

Oil-free screw blowers

ZS 4, ZS 4 VSD & ZS 4 VSD⁺ (37-90 kW / 50-120 hp)

Atlas Copco





High process uptime at low lifecycle cost

Energy costs can add up to 80% of the lifecycle cost of a blower. That's why we constantly develop new blower models, consuming a minimum level of energy, such as the ZS VSD⁺. The Atlas Copco oil-free screwblower element is driven by our in-house developed liquid cooled permanent magnet motor. Combined with the Neos VSD inverter, this successful energy-efficient variable speed driven solution runs trouble-free in the harshest environments.

With the ZS VSD⁺ you don't need to worry about your process uptime and no hidden surprises will occur when receiving the energy bill at the end of the month.

Most energy-efficient variable speed driven blower in the market

Atlas Copco took again a next step in the development of energy-efficient low pressure solutions. The introduction of integrated permanent magnet motors results in the most energy-efficient variable speed driven oil-free screw blower in the market.

Durable and reliable design

For us, every design choice is driven by composing reliable and durable solutions. Our permanent magnet motor housing is foreseen with a liquid cooled jacket to keep it cool in any circumstances. The oil pump is fully integrated ensuring exactly the right amount of cooled oil to the bearings and gears. Transmission from motor to screw element happens over a gearbox.

Ensured process uptime

Start securing your process quality and process uptime by selecting the highest guarantee on pure, 100% Class 0 certified oil-free air delivery.

Fully operational, the **SMARTLINK** monitoring system keeps you informed on-line on the machine-health, proposes pro-actively service interventions and advises you on the operational efficiency of the blower system.

Our commitment: total solution packages fitting easily in your blower room

With the ZS & ZS VSD⁺ you get a compact Plug & Play blower solution. It will fit in your existing blower room - if you have that already - or next to it if you would prefer so. The design is flexible when it comes to the installation setup; maintenance and inspection can be done from front & back so you are free to install them side-by-side. The blowers can be installed outside in pretty tough environments, we allow ambient conditions with temperatures up to 50°C/120°F.



A complete package for all your applications

Built to ensure complete product safety, ZS blowers ensure a continuous, flexible, highly reliable and energy-efficient 100% oil-free air supply in all your low pressure applications at the lowest possible operational cost.



— **Wastewater treatment**

Water is essential to life on our planet - a planet that never stops turning... There is a continuous (but variable!) demand to purify and recycle wastewater. Reliability, flexibility and energy- efficiency are crucial elements; the ZS VSD⁺ provides them all. It is a solid, agile variable speed driven blower coping with the wide range of air flow demand. Its high energy efficiency level limits energy costs, which typically represent 70% of the total operational cost in water treatment plants.

— **Pneumatic conveying**

For pneumatic conveying you need a heavy duty blower, able to cope with powder transfer hick-ups and a true variable system demand. The ZS components are carefully selected; the ZS is the strong blower that will serve you for many years with minimal downtime.

Pneumatically conveying products is expensive - the energy costs account for about 80% of the blower life cycle cost. Therefore the high energy efficiency level and the low maintenance costs of the ZS VSD⁺ blower will reduce the cost of your end product.





Fermentation

In the fermentation process, it is crucial to follow the exact fermentation recipe. This process needs accurate air flow control from minimum to maximum demand; the blower should in the meantime be able to handle an increasing pressure requirement over the fermentation cycle. The agile ZS VSD+ units have the required operating profile ensuring the most energy-efficient, as they are able to run at each operating point.

Non-woven textile

The textile industry runs 24/7 in a continuous but changing process mode; the ZS easily handles the need for adjustable flow in order to influence fiber characteristic and does it in the most energy efficient way, fully exploiting the benefits of its permanent magnet motor at partial load. The screwblower's canopy is designed with care to ensure a low noise level. You don't need to foresee extra measures connecting the blower in your blower room: the units are ready and easy to use.



ZS 4 VSD⁺

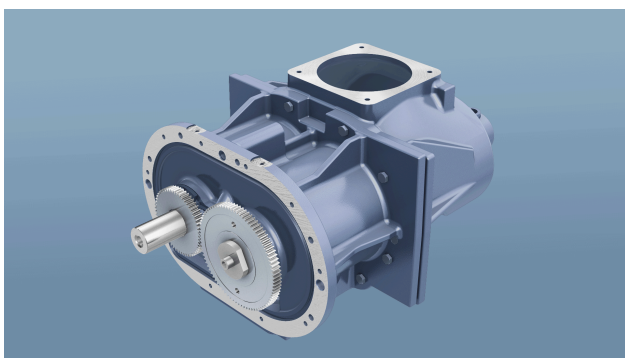

1. Efficient, clean and reliable compression

- Certified oil-free compression technology (Class 0 certified)
- Durably-coated rotors ensure optimal operational clearances
- Perfectly sized and timed inlet- and outlet port and rotor profile result in the lowest specific power consumption
- Tuned cool oil injection to bearings and gears maximizing the lifetime

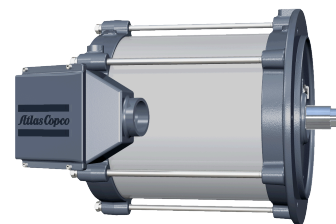

2. Highly efficient oil-cooled Permanent Magnet motor

- Highest full-load motor efficiency: no waste of energy in redundant copper losses
- Constant (high) Power Factor at partial load
- Liquid cooled housing improves efficiency, extends lifetime
- IP66 rated fully enclosed motor housing for operation in the harshest environmental conditions

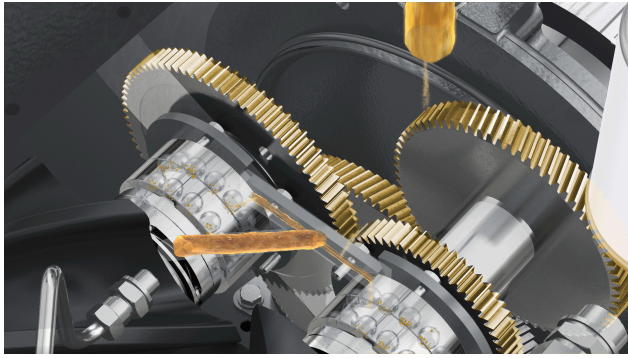

3. Reliability by ensured cooling and lubrication of bearings, gears and motor housing

- Integrated oil pump, directly driven with the blower element
- Oil injection nozzles spray the optimal amount of cooled and filtered oil to each bearing/gear
- Permanent Magnet motor housing is oil cooled enhancing its lifetime

4. Most efficient transmission, minimum maintenance required!

- Motor-screwblower transmission over a heavy duty gearbox
- Low maintenance costs, no wearing components such as belts, pulleys, ...
- A gear transmission is stable over time, ensuring the promised unit energy level over its full life cycle

5. Advanced touch screen monitoring system

- User-friendly Elektronikon® Touch
- Advanced connectivity capabilities thanks to system process controller and/or Optimizer 4.0
- Included warning indications, maintenance scheduling and online visualization of the machine's condition

6. Fully integrated Neos VSD inverter

- Integrated solution to maximize blower turndown at highest efficiency level
- In-house design: complete solution, improved control, guaranteed spare parts availability
- Trouble-free operation in harshest conditions: IP5X protection degree, aluminum enclosure protecting from dust and moisture

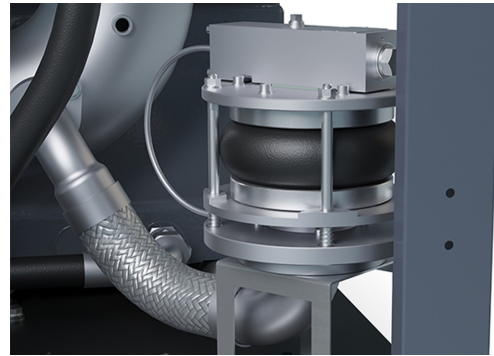

7. Built-in mechanical integrity & protection

- Integrated start-up and safety valve: smooth start-up, ensured over-pressure protection
- Atlas Copco check-valve design: minimal pressure drop, ensured operation
- High-efficiency inlet filter (particles up to 3 μ at a performance of 99.9% are filtered)

8. Silent canopy, silent blower

- Inlet baffle silencing with minimum pressure drop and high sound absorption characteristics
- Sealed canopy panels and doors
- Discharge pulsation damper attenuates dynamic pulsation levels in the air flow to the minimum

9. Installation flexibility - outdoor variant

- Optional canopy panels for outdoor operation

ZS 4 VSD

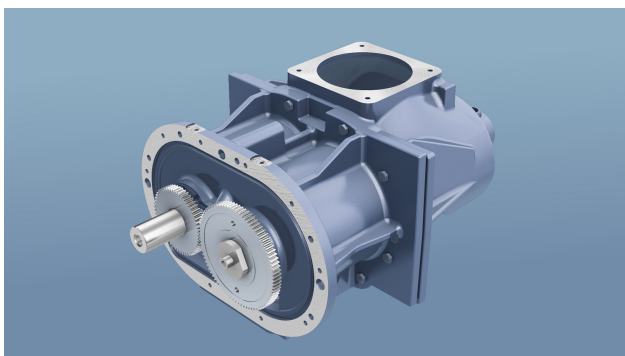
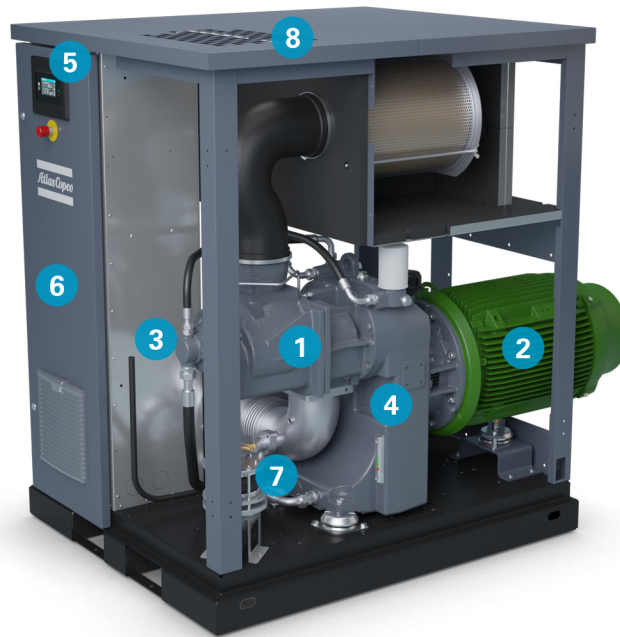

1. Efficient, clean and reliable compression

- Certified oil-free compression technology (Class 0 certified)
- Durably-coated rotors ensure optimal operational clearances
- Perfectly sized and timed inlet- and outlet port and rotor profile result in the lowest specific power consumption
- Tuned cool oil injection to bearings and gears maximizing the lifetime

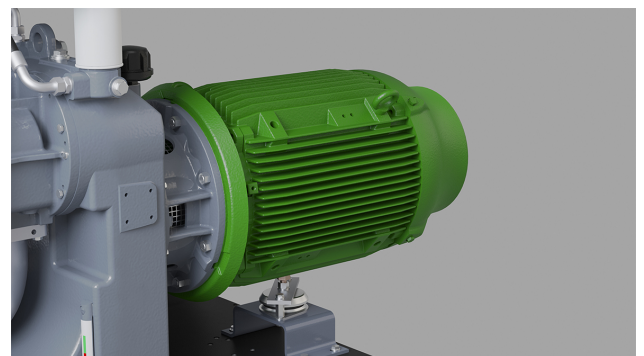

2. High-efficient motor

- IE3 & Nema premium efficient motor
- TEFC for operation in the harshest environmental conditions

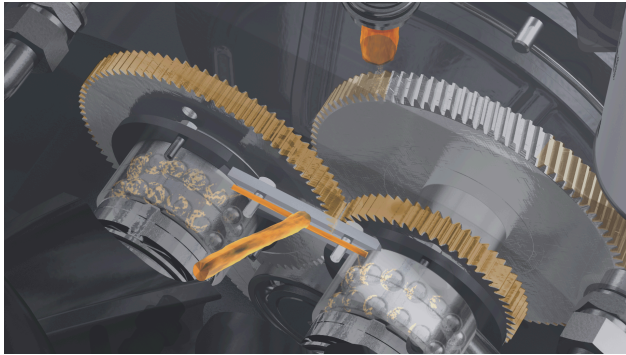

3. Reliability by ensured cooling and lubrication of bearings and gears

- Integrated oil pump, directly driven with the blower element
- Oil injection nozzles spray the optimal amount of cooled and filtered oil to each bearing/gear

4. Most efficient transmission, minimum maintenance required!

- Motor-screwblower transmission over a heavy duty gearbox
- Low maintenance costs, no wearing components such as belts, pulleys, ...
- A gear transmission is stable over time, ensuring the promised unit energy level over its full life cycle

5. Advanced touch screen monitoring system

- User-friendly Elektronikon® Touch
- Advanced connectivity capabilities thanks to system process controller and/or Optimizer 4.0
- Included warning indications, maintenance scheduling and online visualization of the machine's condition

6. Fully integrated Neos VSD inverter

- Integrated solution to maximize blower turndown at highest efficiency level
- In-house design: complete solution, improved control, guaranteed spare parts availability
- Trouble-free operation in harshest conditions: IP5X protection degree, aluminum enclosure protecting from dust and moisture

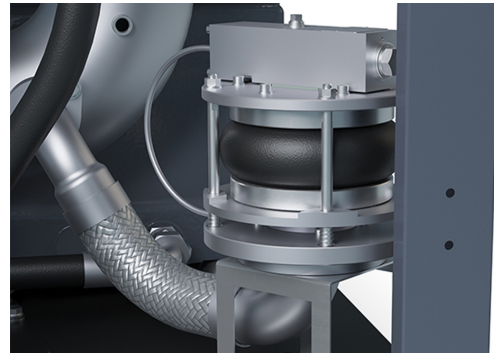

7. Built-in mechanical integrity & protection

- Integrated start-up and safety valve: smooth start-up, ensured over-pressure protection
- Atlas Copco check-valve design: minimal pressure drop, ensured operation
- High-efficiency inlet filter (particles up to 3 μ at a performance of 99.9% are filtered)

8. Silent canopy, silent blower

- Inlet baffle silencing with minimum pressure drop and high sound absorption characteristics
- Sealed canopy panels and doors
- Discharge pulsation damper attenuates dynamic pulsation levels in the air flow to the minimum

9. Installation flexibility - outdoor variant

- Optional canopy panels for outdoor operation

ZS 4

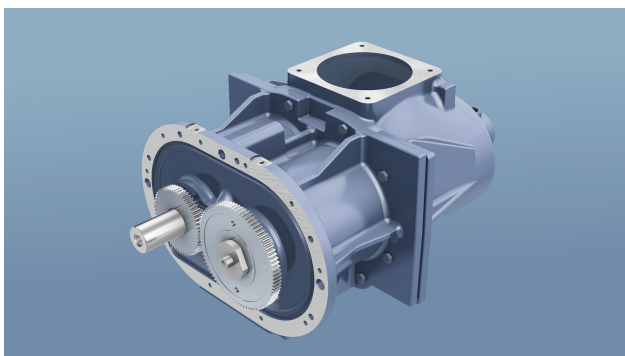
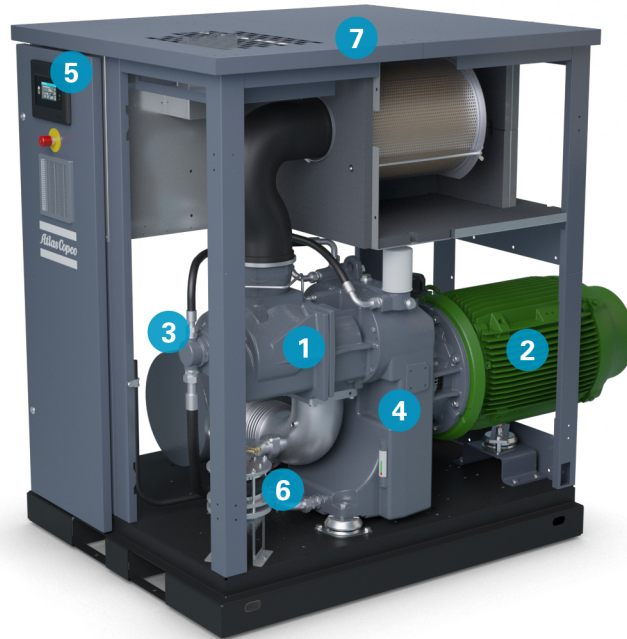

1. Efficient, clean and reliable compression

- Certified oil-free compression technology (Class 0 certified)
- Durably-coated rotors ensure optimal operational clearances
- Perfectly sized and timed inlet- and outlet port and rotor profile result in the lowest specific power consumption
- Tuned cool oil injection to bearings and gears maximizing the lifetime

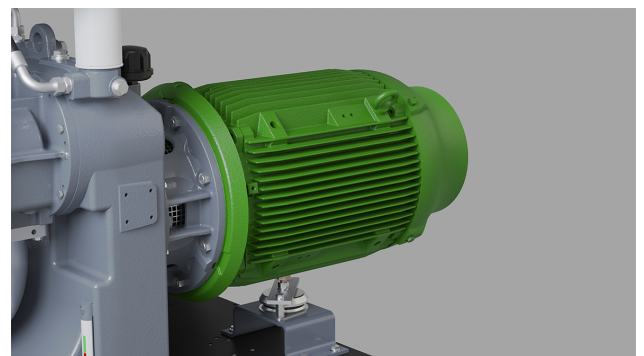

2. High-efficient motor

- IE3 & Nema premium efficient motor
- TEFC for operation in the harshest environmental conditions

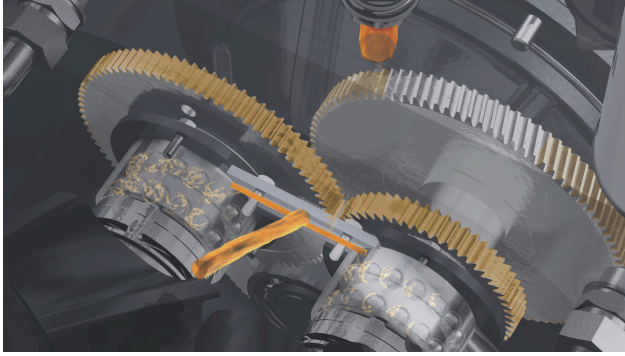

3. Reliability by ensured cooling and lubrication of bearings and gears

- Integrated oil pump, directly driven with the blower element
- Oil injection nozzles spray the optimal amount of cooled and filtered oil to each bearing/gear

4. Most efficient transmission, minimum maintenance required!

- Motor-screwblower transmission over a heavy duty gearbox
- Low maintenance costs, no wearing components such as belts, pulleys, ...
- A gear transmission is stable over time, ensuring the promised unit energy level over its full life cycle

5. Advanced touch screen monitoring system

- User-friendly Elektronikon® Touch
- Advanced connectivity capabilities thanks to system process controller and/or Optimizer 4.0
- Included warning indications, maintenance scheduling and online visualization of the machine's condition

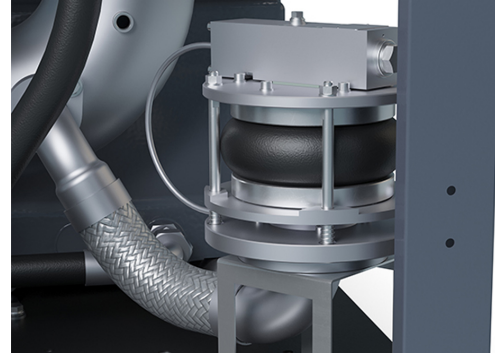

6. Built-in mechanical integrity & protection

- Integrated start-up and safety valve: smooth start-up, ensured over-pressure protection
- Atlas Copco check-valve design: minimal pressure drop, ensured operation
- High-efficiency inlet filter (particles up to 3 μ at a performance of 99.9% are filtered)

7. Silent canopy, silent blower

- Inlet baffle silencing with minimum pressure drop and high sound absorption characteristics
- Sealed canopy panels and doors
- Discharge pulsation damper attenuates dynamic pulsation levels in the air flow to the minimum

8. Installation flexibility - outdoor variant

- Optional canopy panels for outdoor operation

Installation flexibility

You will love to plug in the new ZS and/or ZS VSD⁺ screwblower in your system; wherever you have it in mind, it will fit!



The smallest screwblower in the market

The new ZS VSD⁺ is really small. No issues anymore while replacing your old blower system with our screwblower. Ours will definitely fit in the same area. Also for new installations, this will help you to minimize your installation investments...

Side-by-side installation

Push it to the limits. Squeeze in as many ZS screwblowers as physically possible. The forklift slots are foreseen at the front; roll-in and park the blower in the row; interfaces for air outlet, (ducted) air inlet are at the back side, power cables can enter from the roof top. Once installed, operation is done from the front (or remotely), periodic maintenance is done from front and back.

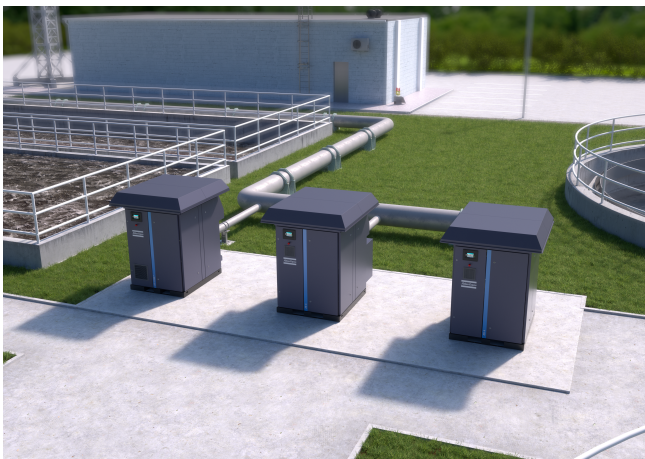

Outdoor operation

No need for a dedicated blower room, no need for excessively long piping...

You can install the ZS & ZS VSD⁺ screwblowers wherever you think it is the most convenient, using the bolt-on outdoor-kit.

Separate process air inlet grating

All process air is taken through a single inlet grating, this makes it feasible to 'pipe' the inlet for better control.



Class 0: the industry standard



Class 0: oil-free air

Oil-free air is used in all kinds of industries where air quality is paramount for the end product and production process. These applications include food and beverage processing, pharmaceutical manufacturing and packaging, chemical and petrochemical processing, semiconductor and electronics manufacturing, the medical sector, automotive paint spraying, textile manufacturing and many more. In these critical environments, contamination by even the smallest quantities of oil can result in costly production downtime and product spoilage.

First in oil-free air technology

Over the past sixty years Atlas Copco has pioneered the development of oil free air technology, resulting in a range of air compressors and blowers that provide 100% pure, clean air. Through continuous research and development, Atlas Copco achieved a new milestone, setting the standard for air purity as the first manufacturer to be awarded ISO 8573-1 CLASS 0 certification.



| CLASS | Concentration total oil (aerosol, liquid, vapor) mg/m ³ |
|-------|--|
| 0 | As specified by the equipment user or supplier and more stringent than class 1 |
| 1 | < 0.01 |
| 2 | < 0.1 |
| 3 | < 1 |
| 4 | < 5 |

Current ISO 8573-1 (2010) classes (the five main classes and the associated maximum concentration in total oil content).

Eliminating any risk

As the industry leader committed to meeting the needs of the most demanding customers, Atlas Copco requested the renowned TÜV institute to type-test its range of oil-free compressors and blowers. Using the most rigorous testing methodologies available, all possible oil forms were measured across a range of temperatures and pressures. The TÜV found no traces of oil at all in the output air stream. Thus Atlas Copco is not only the first compressor and blower manufacturer to receive CLASS 0 certification, but also exceeds ISO 8573-1 CLASS 0 specifications.

True package performance

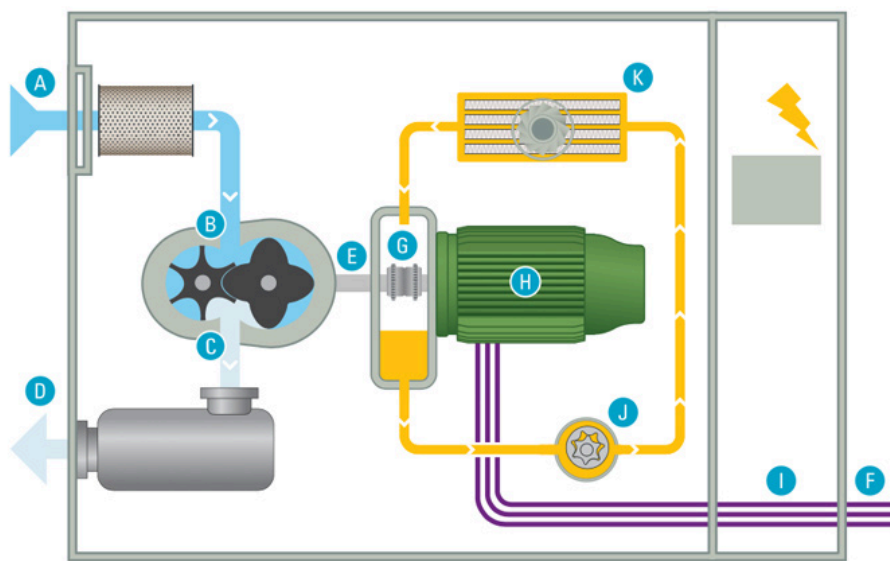

- | | | |
|---------------------------|---------------------------|----------------------|
| A Inlet - Package | G Mechanical drive | ○ Dry compressed air |
| B Inlet - Element | H Motor | ○ Air |
| C Outlet - Element | I Electric drive | ○ Oil |
| D Outlet - Package | J Oil pump | ● Electricity |
| E Shaft power | K Cooling fan | |
| F Package power | | |

Our commitment: delivered flow and package power

In Atlas Copco, performance measurements and reporting are done according to the latest norm (ISO, CAGI etc) considering a full-scope blower.

Performance is measured and reported as such:

- Delivered flow (= unit outlet flow at the customer's demanded pressure)
- Package power (= fully demanded electrical power from the grid at this operating point)

Delivered flow vs (element) inlet flow and package power vs shaft power are substantially different. **Match the true blower performance with your actual need!**

Numerous test and reporting codes exist for blower performance. How to compare?

Shaft power vs package power

- Shaft power = **mechanical power taken by the core/element** to move/compress air from inlet to outlet (typically reported for core/element performance, referring to moving/compressing air from element inlet- to outlet flange)
- Package power = **full electric power taken by the blower package** to move/compress air from package inlet to package outlet.

The difference between package power and shaft power is the sum of: transmission losses between motor and element (high for belts, low for gears, zero for direct drive), motor losses (depends on motor type, largely dependent on full/partial load operation!), electric drive (FS starter or VSD inverter losses) and auxiliaries (cooling fan, pump).

Core performance vs package performance

Some norms/codes discuss the performance of the 'core' of the blower, some of the 'full package'. **Both are relevant, not the same though.**

The core - or element - is the 'heart' of the blower; it is where the electric power is used to move air and build up pressure.

When integrated in a package; typically an inlet filter is installed upfront, a check valve and discharge silencer behind the element. Those **auxiliaries generate pressure drops**; next to that the element inlet flow will be at a higher temperature than the unit inlet grating. These effects result by definition in a "reduced" performance of the blower package compared to the core/element performance (higher power consumption for a lower mass flow).

Plug & play unit

What is the scope of supply? This DOES have an impact on the performance guarantee.

Suppose package performance, based on outlet flow and package power is reported; then it still is **very important to compare the scope of supply of the unit!** Is there an inlet filter integrated in the package? Is there a check valve integrated? Is the VSD inverter integrated in the box? if not, are VSD inverter losses included in the reported package power?

Inlet flow vs outlet flow

- Inlet flow = intake flow = suction flow = aspired flow
- Outlet flow = delivered flow

What goes in must come out? That is not true. All blowers have some leak over the air seals; besides that, some blower technologies - by design - do not deliver all aspired air.

Why can inlet flow reporting be misleading? Often the inlet flow reporting is done based on an element/core suction flow measurement; as discussed in the section "core performance vs package performance", the (flow)performance measured at core-level by definition is better than the one at package-level. As customer it is important to compare the way how flow-performance is guaranteed vs the actual flow-rate demanded by the process (where is the flow 'needed'?).

Flowcharts ZS 4 VSD⁺

Process flow, oil flow and cooling flow - step by step.

ZS VSD⁺

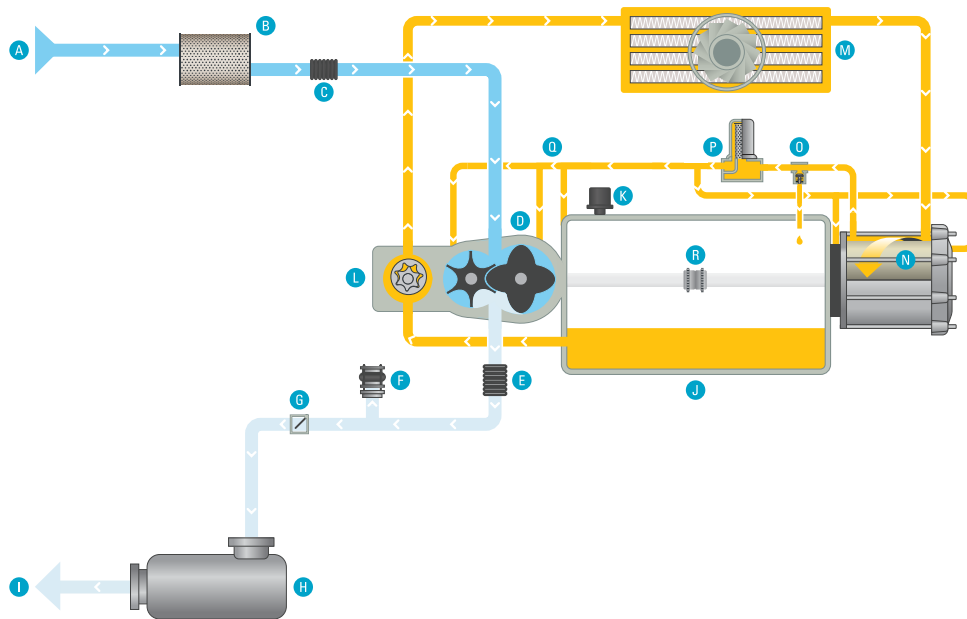

Atlas Copco

- A Air inlet
- B Intake filter
- C Flexible connection
- D Oil free screw blower element
- E Flexible connection
- F Start-up and safety valve
- G Check valve
- H Pulsation damper
- I Air out
- J Oil carter
- K Breather
- L Oil pump
- M Oil cooler
- N Motor jacket cooling
- O Bypass valve
- P Oil filter
- Q Oil injection to bearings & gears
- R Gears

- Dry compressed air
- Air
- Oil

Process flow

- Air intake with noise attenuating baffle system.
- Air is filtered prior to entering the screwblower element.
- Internal compression in the oil-free screwblower element.
- At start-up, the blow-off valve is 'open' for smooth unit start-up. That valve closes itself, pushed by the increased air pressure.
- As soon as the blow-off valve is closed, air pressure increases further, resulting in enough force to push the check-valve open.
- Discharge silencer reduces the pressure pulsation levels to the minimum.
- Air delivery to the system.

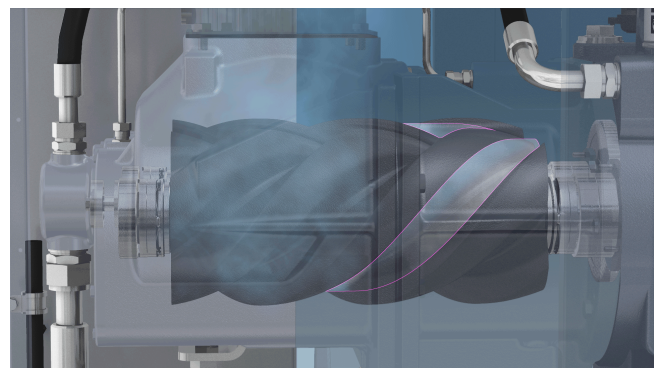

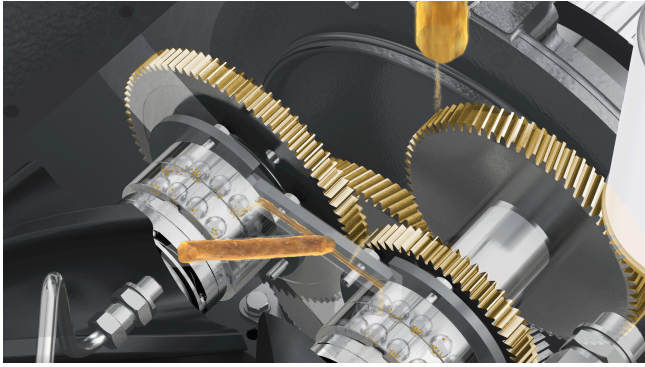

Oil flow

- Oil pump, mounted on screwblower shaft hence directly driven.
- Oil suction from carter, integrated in the gearbox.
- All oil is pumped to oil cooler; all oil is cooled.
- Cool oil flows through Permanent Magnet motor cooling jacket.
- Bypass valve decides exact oil flow that is required for bearing- and gear cooling and lubrication.
- That oil first is fine-filtered.
- Filtered cool oil is distributed to individually tuned oil nozzles per bearing and/or gear in screwblower element, gearbox and Permanent Magnet motor.
- Internal drains recover all oil in the carter (in the gearbox).

Cooling flow

- One cooling fan pulls the hot air out of the canopy.
- Fresh air is taken from the unit back side.
- That air first passes a noise attenuating baffle system.
- The cooling fan forces the canopy air through the oil cooler, taking away the heat of the oil. The hot air then leaves the canopy through the roof-top grating.
- The VSD cubicle is cooled with fresh air taken-in through filters in the front door.
- Cubicle fans push the hot air out of the cubicle, the hot air can leave the canopy through the same roof-top grating.

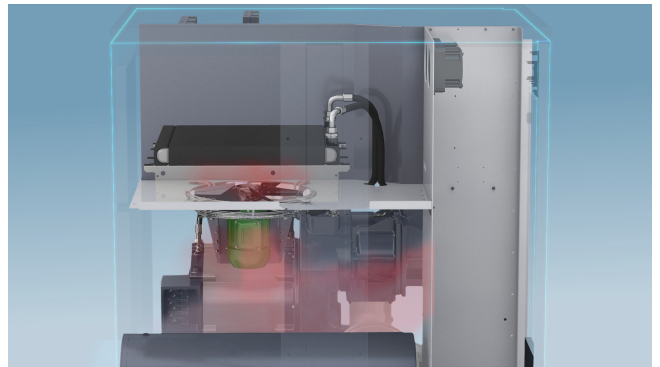

Flowcharts ZS 4 & ZS 4 VSD

Process flow, oil flow and cooling flow - step by step.

ZS & ZS VSD

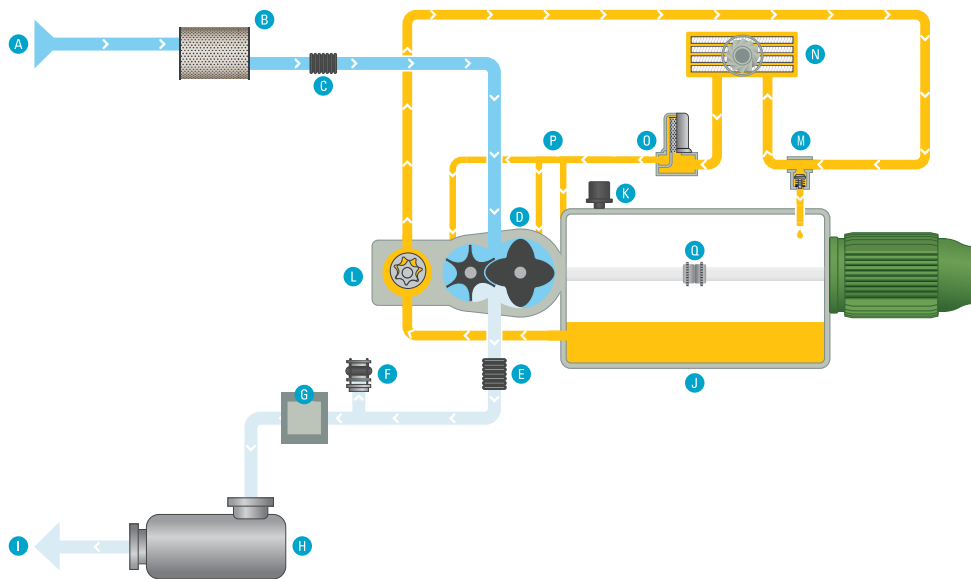

Atlas Copco

- A Air inlet
- B Intake filter
- C Flexible connection
- D Oil free screw blower element
- E Flexible connection
- F Start-up and safety valve
- G Check valve
- H Pulsation damper
- I Air out
- J Oil carter
- K Breather
- L Oil pump
- M Bypass valve
- N Oil cooler
- O Oil filter
- P Oil injection to bearings & gears
- U Gears

- Dry compressed air
- Air
- Oil

Process flow

- Air intake with noise attenuating baffle system.
- Air is filtered prior to entering the screwblower element.
- Internal compression in the oil-free screwblower element.
- At start-up, the blow-off valve is 'open' for smooth unit start-up. That valve closes itself, pushed by the increased air pressure.
- As soon as the blow-off valve is closed, air pressure increases further, resulting in enough force to push the check-valve open.
- Discharge silencer reduces the pressure pulsation levels to the minimum.
- Air delivery to the system.

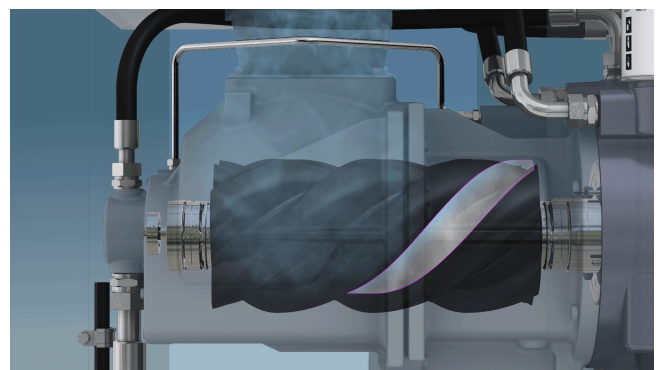

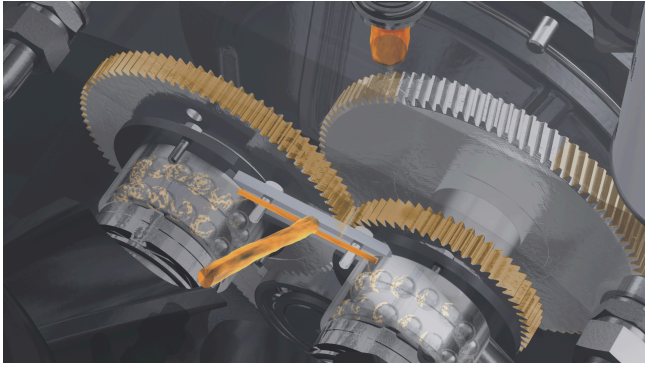

Oil flow

- Oil pump, mounted on screwblower shaft hence directly driven.
- Oil suction from carter, integrated in the gearbox.
- Bypass valve decides exact oil flow that is required for bearing- and gear cooling and lubrication.
- That oil first is pumped through the oil cooler.
- Then the cool oil is fine-filtered.
- Filtered cool oil is distributed to individually tuned oil nozzles per bearing and/or gear in screwblower element and gearbox.
- Internal drains recover all oil in the carter (in the gearbox).

Cooling flow

- One cooling fan pulls fresh air from the unit back side.
- That fresh air is pushed through the oil cooler, taking away the heat of the oil.
- In parallel, the motor cooling fan also pulls fresh air from the unit back side. The motor fan-cowl ensures that air flowing over the motor cooling fins.
- The cubicle is cooled with fresh air taken-in through filters in the front door.
- Cubicle fans push the hot air out of the cubicle, in the canopy.
- The hot canopy air (oil cooling heat, motor cooling heat and cubicle heat) can leave the canopy through a roof-top grating. A noise attenuating baffle is installed.

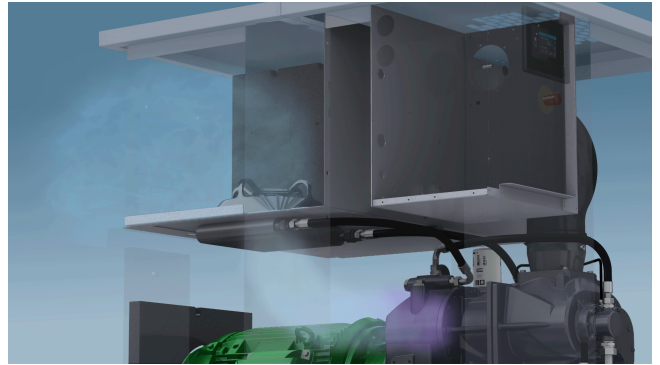

Monitoring and control

Get the best out of your installation!

Elektronikon®

The Elektronikon® unit controller is specially designed to maximize the performance of your blowers under a variety of conditions. Optimizer 4.0 takes charge of the management of your full blower room. Key benefits are increased energy-efficiency by lowering energy consumption, reduced maintenance times and less stress... less stress for both you and your entire air system.



Elektronikon® MK5 Touch - Intelligence is part of the package

The full color touch display gives you an easy-to-understand readout of the equipment's running conditions.

- Clear icons and intuitive navigation provides you fast access to all of the important settings and data.
- Monitoring of the equipment running conditions and maintenance status; bringing this information to your attention when needed.
- Operation of the equipment to deliver specifically and reliably to your compressed air needs.
- Built-in remote control- and notification functions provided as standard, including simple to use integrated webpage.
- Support for 31 different languages, including character based languages.

Connectivity, with SMARTLINK

Monitor your machines over the ethernet with the Elektronikon® unit controller and the **SMARTLINK** service. Monitoring features include warning indications, compressor shut-down, sensor trending and maintenance scheduling.

Go for energy efficiency: customized reports will be generated on the energy efficiency of your blower room, in compliance with ISO 50001.



Sit back and relax, Optimizer 4.0 has it under control

A properly managed compressed air network will save energy, reduce maintenance, decrease downtime, increase production and improve product quality. Atlas Copco's Optimizer 4.0 monitors and controls multiple blowers simultaneously; it is one central point of control for the whole compressed air network, ensuring all blowers provide optimum performance for your process. The result is a completely autonomous and energy-efficient network, giving you peace of mind and keeping your costs minimized.



Maximize your resources with a Service Plan

Reduce your total cost of ownership and benefit from optimal performance

Optional maintenance will reduce the operational cost of your blower system. Operational efficiency is increased as our maintenance expertise makes life easier when it comes to resource management. Specialist services keeps your equipment running as it should, protecting your investment and guaranteeing high uptime and performance.



Blower parts at your doorstep: our Parts Plan

Genuine Parts, designed and produced to the exact specifications of your blower, delivered right where and when you need them.

- All parts, one package - Always have the needed part for your service intervention at hand.
- Save money - A Service Kit costs less than the sum of its components if ordered separately.
- Less administration - Every Service Kit has a single part number, allowing you to create a simple purchase order that is easy to follow up.

Fixed Price Services: best blower parts & maintenance

Avoid financial surprises. Our Fixed Price Services combine the expertise of factory-trained technicians with the quality of our genuine blower parts.

- The best blower parts - The unrivalled quality of our genuine parts results in optimal uptime, energy consumption and reliability.
- An expert maintenance plan - Rely on the expertise of factory-trained Atlas Copco technicians.
- Clear and easy - Tailored to your installation, site conditions, and production planning, every Fixed Price Service has a clear scope and price.





Preventive Maintenance Plan for optimal blower uptime

Rely on trained Atlas Copco technicians and the unrivalled quality of our genuine parts.

- Service reports - We help you achieve maximum energy efficiency by keeping you up to date of the status of your system.
- Prevent breakdown - If our technicians spot an additional developing problem, they will propose a solution.
- op-priority emergency call out system - If an urgent repair is needed, you get priority assistance.

Complete blower care with our Total Responsibility Plan

We take care of all your blower maintenance, upgrades, repairs and even breakdowns for an all-inclusive price.

- Complete blower care - On-time maintenance by expert service engineers, genuine parts, proactive upgrades and blower overhauls.
- Total risk coverage - This means we take care of all your blower repairs and even breakdowns, without extra charges.
- Ultimate efficiency - Fitting the latest drive line components gives you as-new levels of compressor efficiency and reliability.



Technical specifications ZS 4

| TYPE | Working pressure | | Max Capacity FAD (1) | | Noise level (2) | Installed motor power | | Weight | | Dimensions L/L(3) x W x H | |
|-------------------------|------------------|------|----------------------|------|-----------------|-----------------------|-----|--------|------|-------------------------------------|-----------------------------|
| | mbar(g) | psig | m ³ /hr | cfm | dB(A) | kW | hp | kg | lb | mm | in |
| ZS 4 37 kW 600 mbar | 600 | 8.7 | 2125 | 1250 | 75 | 37 | 50 | 1100 | 2450 | 1500/1850 x 1250 x 1720 | 59/73 x 49 x 68 |
| ZS 4 37 kW 800 mbar | 800 | 11.6 | 1675 | 1000 | 75 | | | | | | |
| ZS 4 37 kW 1000 mbar | 1000 | 14.5 | 1450 | 850 | 75 | | | | | | |
| ZS 4 37 kW 1200 mbar | 1200 | 17.4 | 1150 | 675 | 75 | | | | | | |
| ZS 4 45 kW 600 mbar | 600 | 8.7 | 2450 | 1450 | 76 | 45 | 60 | 1100 | 2450 | 1500/1850 x 1250 x 1720 | 59/73 x 49 x 68 |
| ZS 4 45 kW 800 mbar | 800 | 11.6 | 2125 | 1250 | 76 | | | | | | |
| ZS 4 45 kW 1000 mbar | 1000 | 14.5 | 1750 | 1050 | 76 | | | | | | |
| ZS 4 45 kW 1200 mbar | 1200 | 17.4 | 1450 | 850 | 76 | | | | | | |
| ZS 4 45 kW 1500 mbar | 1500 | 21.8 | 1075 | 625 | 76 | 55 | 75 | 1100 | 2450 | 1500/1850 x 1250 x 1720 | 59/73 x 49 x 68 |
| ZS 4 55 kW 600 mbar | 600 | 8.7 | 2450 | 1650 | 77 | | | | | | |
| ZS 4 55 kW 800 mbar | 800 | 11.6 | 2450 | 1450 | 77 | | | | | | |
| ZS 4 55 kW 1000 mbar | 1000 | 14.5 | 2125 | 1250 | 77 | | | | | | |
| ZS 4 55 kW 1200 mbar | 1200 | 17.4 | 1750 | 1050 | 77 | 75 | 100 | 1350 | 3000 | 1500/2000 x 1250 x 1720 | 59/79 x 49 x 68 |
| ZS 4 55 kW 1500 mbar | 1500 | 21.8 | 1450 | 850 | 77 | | | | | | |
| ZS 4 75 kW 600 mbar | 600 | 8.7 | 3000 | 1750 | 78 | | | | | | |
| ZS 4 75 kW 800 mbar | 800 | 11.6 | 3000 | 1750 | 78 | | | | | | |
| ZS 4 75 kW 1000 mbar | 1000 | 14.5 | 2825 | 1650 | 78 | 90 | 120 | 1350 | 3000 | 1500/2000 x 1250 x 1720 | 59/79 x 49 x 68 |
| ZS 4 75 kW 1200 mbar | 1200 | 17.4 | 2475 | 1450 | 78 | | | | | | |
| ZS 4 75 kW 1500 mbar | 1500 | 21.8 | 2025 | 1200 | 78 | | | | | | |
| ZS 4 90 kW 600 mbar | 600 | 8.7 | 3000 | 1750 | 79 | | | | | | |
| ZS 4 90 kW 800 mbar | 800 | 11.6 | 3000 | 1750 | 79 | 90 | 120 | 1350 | 3000 | 1500/2000 x 1250 x 1720 | 59/79 x 49 x 68 |
| ZS 4 90 kW 1000 mbar | 1000 | 14.5 | 3000 | 1750 | 79 | | | | | | |
| ZS 4 90 kW 1200 mbar | 1200 | 17.4 | 2675 | 1575 | 79 | | | | | | |
| ZS 4 90 kW 1500 mbar | 1500 | 21.8 | 2225 | 1300 | 79 | | | | | | |

(1) Unit performance measured according to ISO 1217, Annex C & E, Edition 4 (2009)

Reference conditions:

- Absolute inlet pressure 1 bar (14.5 psi).
- Intake air temperature 20°C (68°F).

(2) A-weighted emission sound pressure level at the work station, L_p WSA (re 20 µPa) dB (with uncertainty 3 dB).
Values determined according to noise level test code ISO 2151 and noise measurement standard ISO 9614.

(3) L' = length of the unit including motor-backpack

Technical specifications ZS 4 VSD

| TYPE | Working pressure | | Max Capacity FAD (1) | | Noise level (2) | Installed motor power | | Weight | | Dimensions L/L'(3) x W x H | |
|-----------------------------|------------------|------|----------------------|------|-----------------|-----------------------|-----|--------|------|-------------------------------------|-----------------------------|
| | mbar(g) | psig | m ³ /hr | cfm | dB(A) | kW | hp | kg | lb | mm | in |
| ZS 4 VSD 37 kW 800 mbar | 600 | 8.7 | 2125 | 1250 | 75 | 37 | 50 | 1150 | 2550 | 1500/1850 x 1250 x 1720 | 59/73 x 49 x 68 |
| | 800 | 11.6 | 1675 | 1000 | 75 | | | | | | |
| | 1000 | 14.5 | 1450 | 850 | 75 | | | | | | |
| ZS 4 VSD 37 kW 1200 mbar | 1200 | 17.4 | 1150 | 675 | 75 | 45 | 60 | 1400 | 3100 | 1500/2000 x 1250 x 1720 | 59/79 x 49 x 68 |
| | 600 | 8.7 | 2450 | 1450 | 76 | | | | | | |
| | 800 | 11.6 | 2125 | 1250 | 76 | | | | | | |
| ZS 4 VSD 45 kW 1000 mbar | 1000 | 14.5 | 1750 | 1050 | 76 | 55 | 75 | 1400 | 3100 | 1500/2000 x 1250 x 1720 | 59/79 x 49 x 68 |
| | 600 | 8.7 | 2450 | 1450 | 76 | | | | | | |
| | 800 | 11.6 | 2125 | 1250 | 76 | | | | | | |
| ZS 4 VSD 45 kW 1200 mbar | 1200 | 17.4 | 1450 | 850 | 76 | 75 | 100 | 1400 | 3100 | 1500/2000 x 1250 x 1720 | 59/79 x 49 x 68 |
| | 600 | 8.7 | 2450 | 1450 | 77 | | | | | | |
| | 800 | 11.6 | 2450 | 1450 | 77 | | | | | | |
| ZS 4 VSD 55 kW 800 mbar | 1000 | 14.5 | 2125 | 1250 | 77 | 90 | 120 | 1400 | 3100 | 1500/2000 x 1250 x 1720 | 59/79 x 49 x 68 |
| | 600 | 8.7 | 2825 | 1650 | 77 | | | | | | |
| | 800 | 11.6 | 2450 | 1450 | 77 | | | | | | |
| ZS 4 VSD 55 kW 1000 mbar | 1200 | 17.4 | 1750 | 1050 | 77 | 75 | 100 | 1400 | 3100 | 1500/2000 x 1250 x 1720 | 59/79 x 49 x 68 |
| | 600 | 8.7 | 2825 | 1650 | 77 | | | | | | |
| | 800 | 11.6 | 2450 | 1450 | 77 | | | | | | |
| ZS 4 VSD 55 kW 1200 mbar | 1200 | 17.4 | 1750 | 1050 | 77 | 75 | 100 | 1400 | 3100 | 1500/2000 x 1250 x 1720 | 59/79 x 49 x 68 |
| | 600 | 8.7 | 2825 | 1650 | 77 | | | | | | |
| | 800 | 11.6 | 2450 | 1450 | 77 | | | | | | |
| ZS 4 VSD 75 kW 1000 mbar | 1200 | 17.4 | 2475 | 1450 | 78 | 90 | 120 | 1400 | 3100 | 1500/2000 x 1250 x 1720 | 59/79 x 49 x 68 |
| | 600 | 8.7 | 3000 | 1750 | 78 | | | | | | |
| | 800 | 11.6 | 3000 | 1750 | 78 | | | | | | |
| ZS 4 VSD 75 kW 1200 mbar | 1200 | 17.4 | 2475 | 1450 | 78 | 90 | 120 | 1400 | 3100 | 1500/2000 x 1250 x 1720 | 59/79 x 49 x 68 |
| | 600 | 8.7 | 3000 | 1750 | 78 | | | | | | |
| | 800 | 11.6 | 3000 | 1750 | 78 | | | | | | |
| ZS 4 VSD 75 kW 1500 mbar | 1200 | 17.4 | 2475 | 1450 | 78 | 90 | 120 | 1400 | 3100 | 1500/2000 x 1250 x 1720 | 59/79 x 49 x 68 |
| | 600 | 8.7 | 3000 | 1750 | 78 | | | | | | |
| | 800 | 11.6 | 3000 | 1750 | 78 | | | | | | |
| ZS 4 VSD 90 kW 1500 mbar | 1200 | 17.4 | 2675 | 1575 | 79 | 90 | 120 | 1400 | 3100 | 1500/2000 x 1250 x 1720 | 59/79 x 49 x 68 |
| | 600 | 8.7 | 2225 | 1300 | 79 | | | | | | |
| | 800 | 11.6 | 2225 | 1300 | 79 | | | | | | |

(1) Unit performance measured according to ISO 1217, Annex C & E, Edition 4 (2009)

Reference conditions:

- Absolute inlet pressure 1 bar (14.5 psi).

- Intake air temperature 20°C (68°F).

(2) A-weighted emission sound pressure level at the work station, L_p WSA (re 20 µPa) dB (with uncertainty 3 dB).

Values determined according to noise level test code ISO 2151 and noise measurement standard ISO 9614.

(3) L' = length of the unit including motor-backpack

Technical specifications ZS 4 VSD+

| TYPE | Working pressure | | Max Capacity FAD (1) | | Noise level (2) | Installed motor power | | Weight | | Dimensions L x W x H | | | |
|------------------------------|------------------|------|----------------------|------|-----------------|-----------------------|-----|--------|------|--------------------------------|--------------------------|----|----|
| | mbar(g) | psig | m ³ /hr | cfm | dB(A) | kW | hp | kg | lb | mm | in | | |
| ZS 4 VSD+ 37 kW 800 mbar | 600 | 8.7 | 2125 | 1250 | 74 | 37 | 50 | 950 | 2100 | 1500 x 1250 x 1720 | 59 x 49 x 68 | | |
| | 800 | 11.6 | 1675 | 1000 | 74 | | | | | | | | |
| ZS 4 VSD+ 75 kW 1200 mbar | 800 | 11.6 | 1675 | 1000 | 74 | | | | | | | | |
| | 1000 | 14.5 | 1450 | 850 | 74 | | | | | | | | |
| ZS 4 VSD+ 45 kW 1000 mbar | 1200 | 17.4 | 1150 | 675 | 74 | | | | | | | 45 | 60 |
| | 600 | 8.7 | 2450 | 1450 | 75 | | | | | | | | |
| ZS 4 VSD+ 45 kW 1200 mbar | 800 | 11.6 | 2125 | 1250 | 75 | | | | | | | | |
| | 1000 | 14.5 | 1750 | 1050 | 75 | | | | | | | | |
| ZS 4 VSD+ 45 kW 1200 mbar | 1200 | 17.4 | 1450 | 850 | 75 | | | | | | | | |
| | 1500 | 21.8 | 1075 | 625 | 75 | | | | | | | | |
| ZS 4 VSD+ 55 kW 800 mbar | 600 | 8.7 | 2825 | 1650 | 76 | 55 | 75 | | | | | | |
| | 800 | 11.6 | 2450 | 1450 | 76 | | | | | | | | |
| ZS 4 VSD+ 55 kW 1000 mbar | 800 | 11.6 | 2450 | 1450 | 76 | | | | | | | | |
| | 1000 | 14.5 | 2125 | 1250 | 76 | | | | | | | | |
| ZS 4 VSD+ 55 kW 1200 mbar | 1000 | 14.5 | 2125 | 1250 | 76 | | | | | | | | |
| | 1200 | 17.4 | 1750 | 1050 | 76 | | | | | | | | |
| ZS 4 VSD+ 55 kW 1500 mbar | 1200 | 17.4 | 1750 | 1050 | 76 | | | | | | | | |
| | 1500 | 21.8 | 1450 | 850 | 76 | | | | | | | | |
| ZS 4 VSD+ 75 kW 1200 mbar | 800 | 11.6 | 3000 | 1750 | 77 | 75 | 100 | | | | | | |
| | 1000 | 14.5 | 2825 | 1650 | 77 | | | | | | | | |
| ZS 4 VSD+ 75 kW 1200 mbar | 1200 | 17.4 | 2475 | 1450 | 77 | | | | | | | | |
| | 1200 | 17.4 | 2475 | 1450 | 77 | | | | | | | | |
| ZS 4 VSD+ 75 kW 1500 mbar | 1200 | 17.4 | 2475 | 1450 | 77 | | | | | | | | |
| | 1500 | 21.8 | 2025 | 1200 | 77 | | | | | | | | |
| ZS 4 VSD+ 90 kW 1500 mbar | 1000 | 14.5 | 3000 | 1750 | 78 | 90 | 120 | | | | | | |
| | 1200 | 17.4 | 2675 | 1575 | 78 | | | | | | | | |
| 1500 | 21.8 | 2225 | 1300 | 78 | | | | | | | | | |

(1) Unit performance measured according to ISO 1217, Annex C & E, Edition 4 (2009)

Reference conditions:

- Absolute inlet pressure 1 bar (14.5 psi).
- Intake air temperature 20°C (68°F).

(2) A-weighted emission sound pressure level at the work station, L_p WSA (re 20 µPa) dB (with uncertainty 3 dB). Values determined according to noise level test code ISO 2151 and noise measurement standard ISO 9614.

COMMITTED TO SUSTAINABLE PRODUCTIVITY

We stand by our responsibilities towards our customers, towards the environment and the people around us. We make performance stand the test of time. This is what we call – Sustainable Productivity.



ISO 9001 • ISO 14001
OHSAS 18001
ISO 22000

www.atlascopco.com

