

INNOVATION

Atlas Copco Capital Markets Day 2014

Nico Delvaux
Business Area President,
Compressor Technique



AGENDA

1. Compressor Technique
2. Innovation drivers
3. How do we work with innovation
4. Innovations
5. Summary

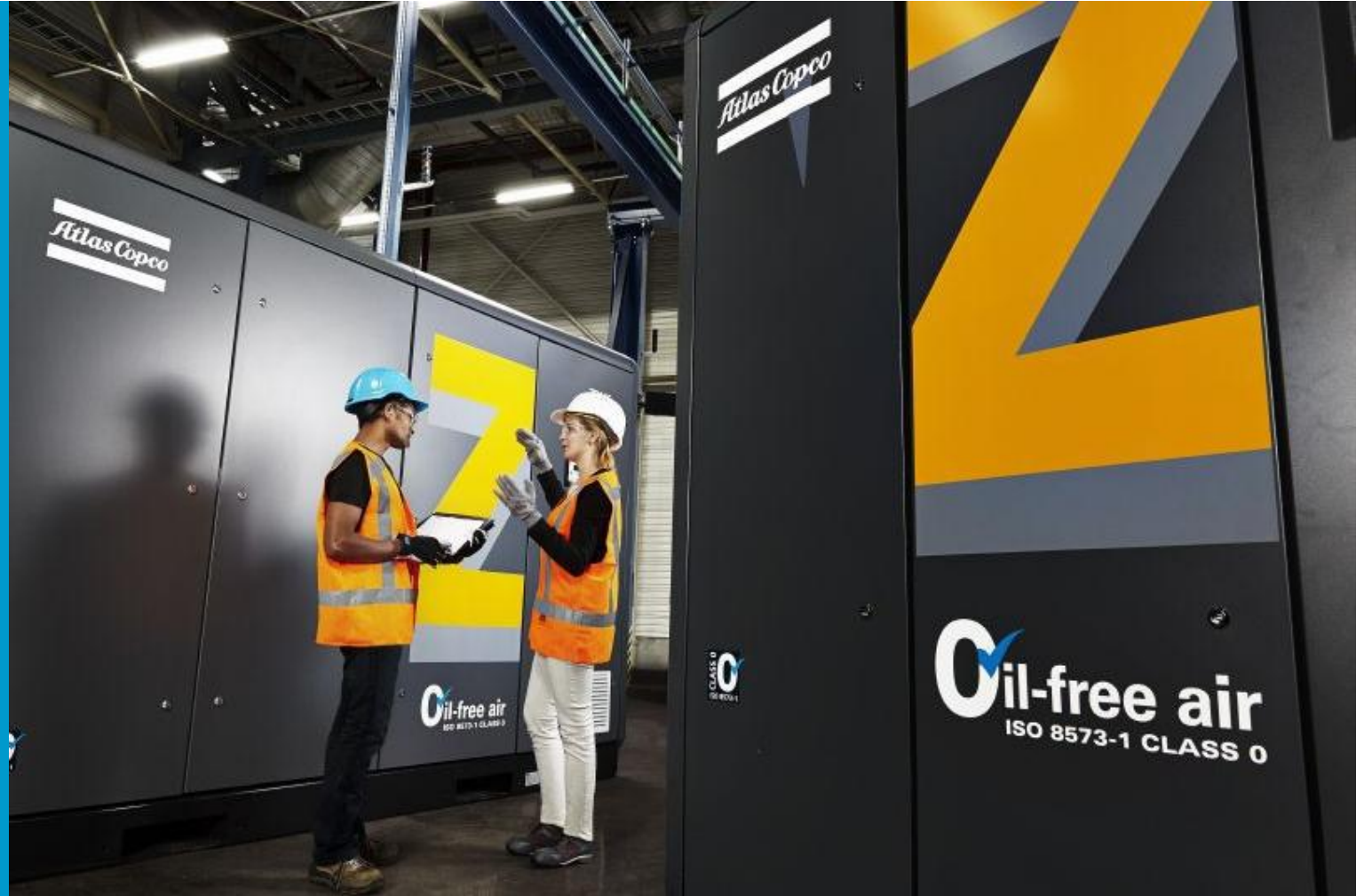

COMPRESSOR TECHNIQUE

Global leader providing innovative compressed air, air and gas treatment and vacuum solutions for sustainable productivity

Profitable growth with asset light and agile organization

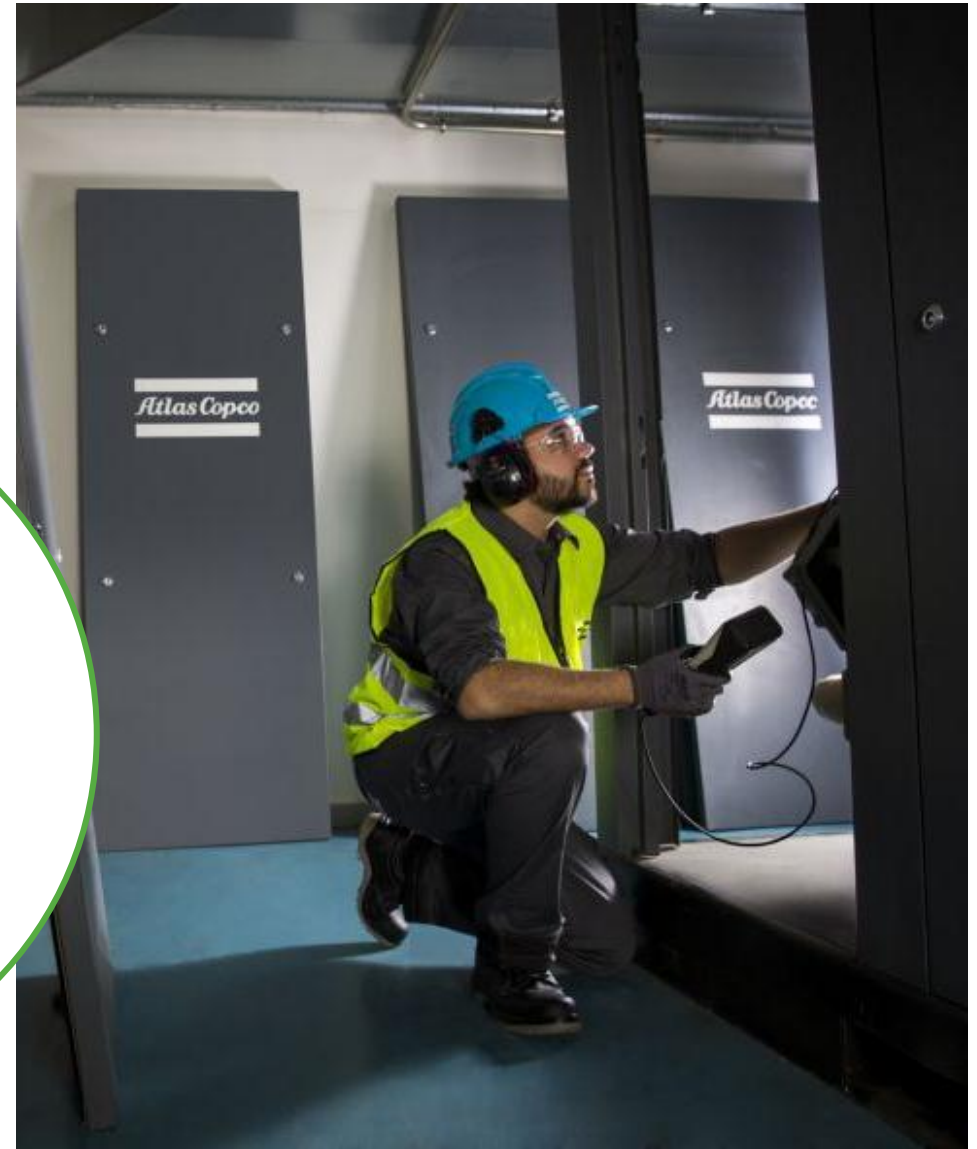

THE STRATEGIC PILLARS FOR PROFITABLE GROWTH

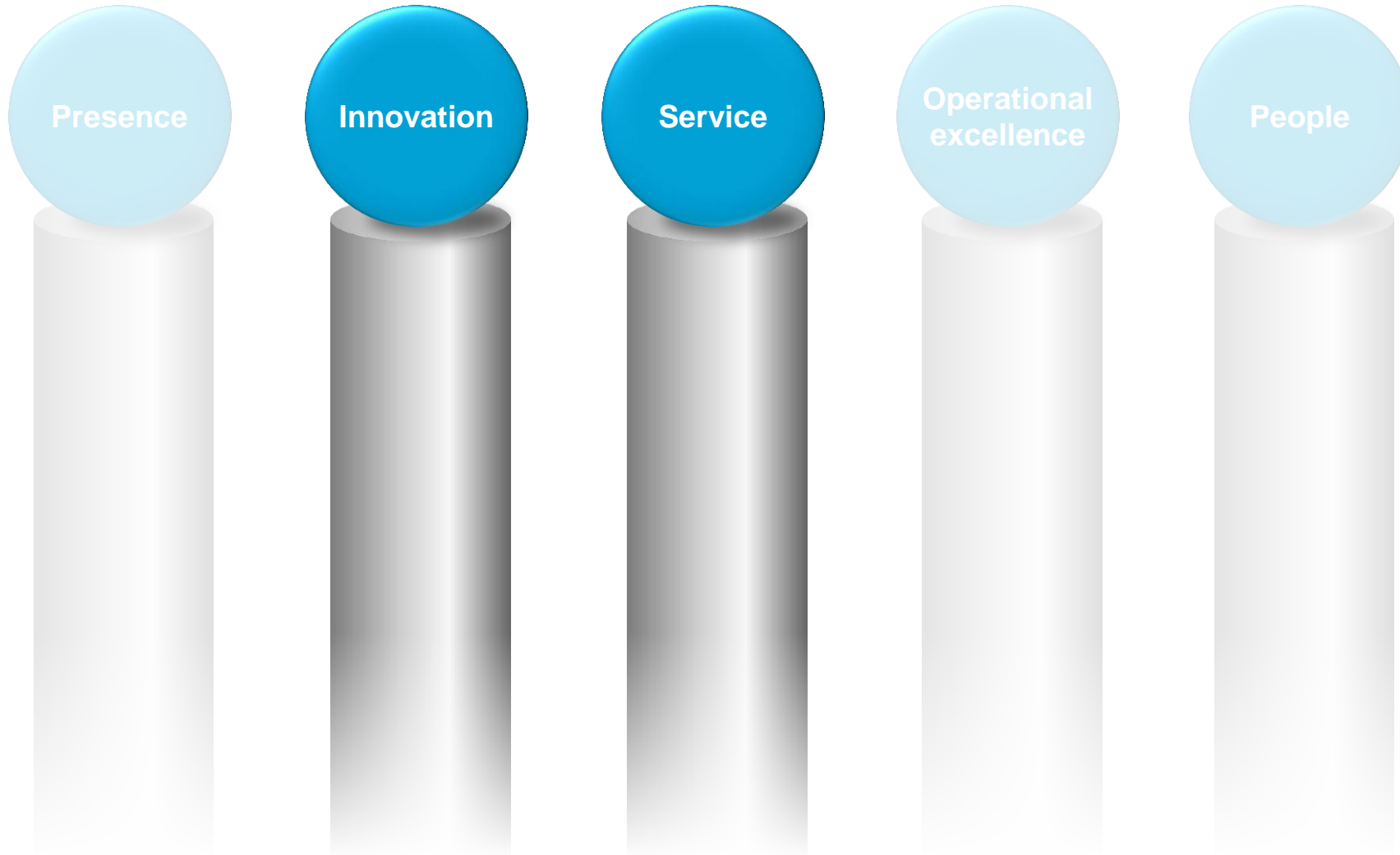

INNOVATION DRIVERS

Trends

The energy efficiency and productivity requirements from industry



Global growth and industry capital investments



Increased labor cost



Growth in emerging markets' middle segment



Environmental awareness



Quicker communication and availability of information



LIFE CYCLE COST COMPRESSOR / VACUUM INSTALLATION

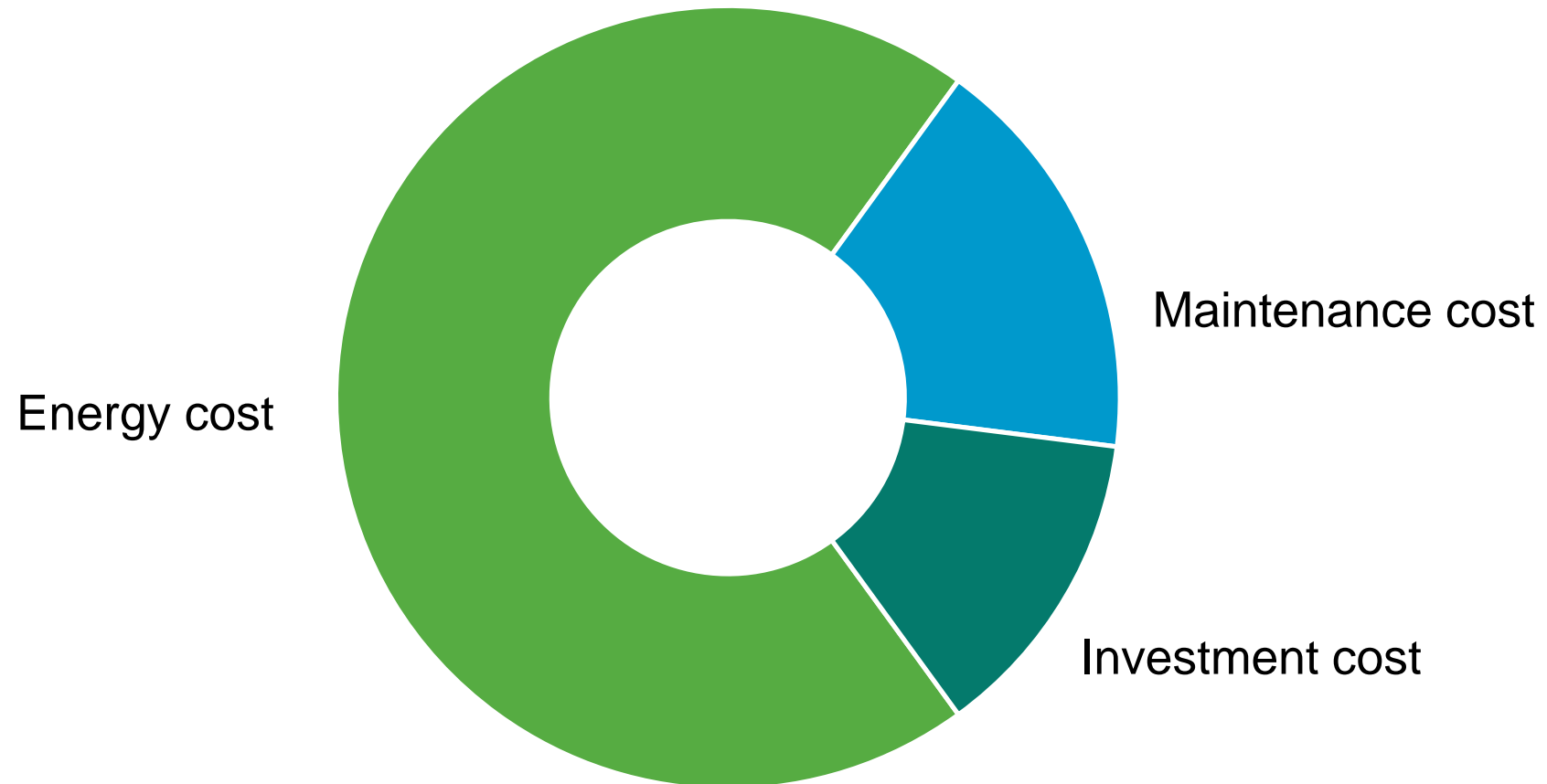

VALUE ADDING INNOVATIONS

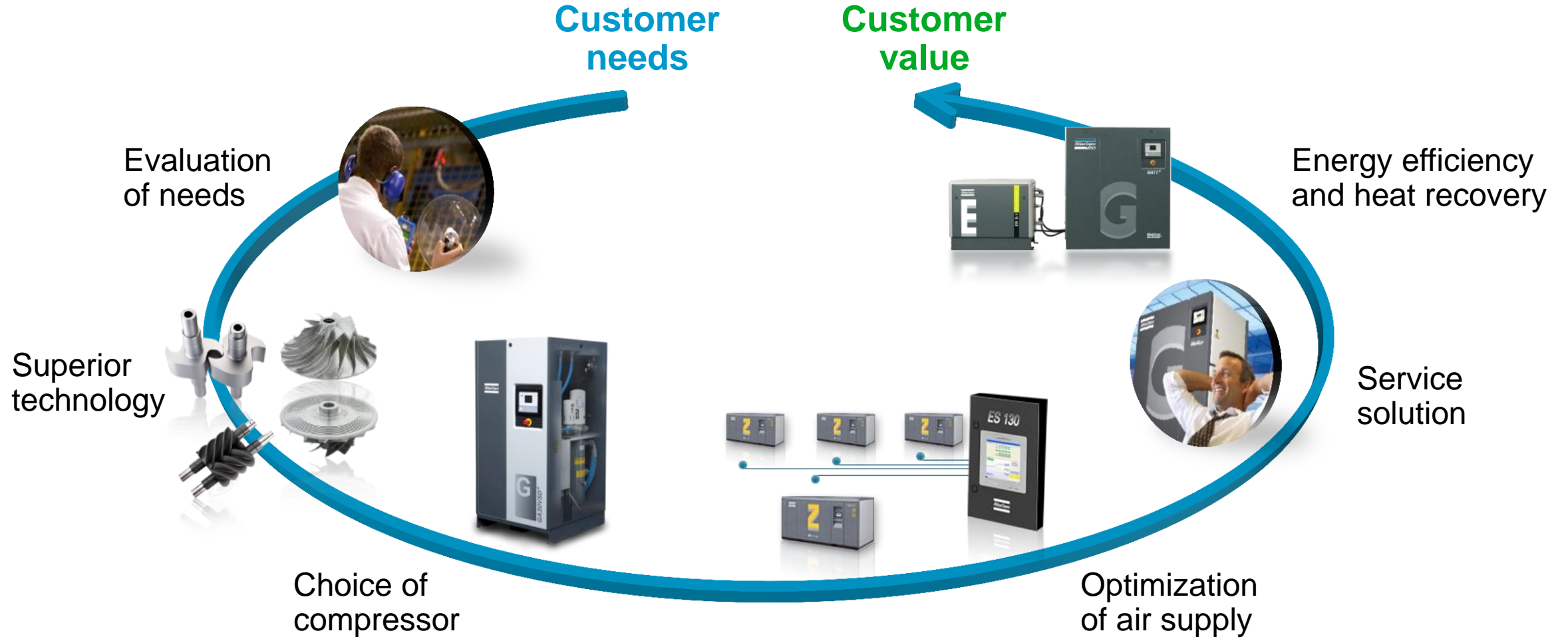

SETTING NEW ENERGY EFFICIENCY STANDARDS

Variable Speed Drive

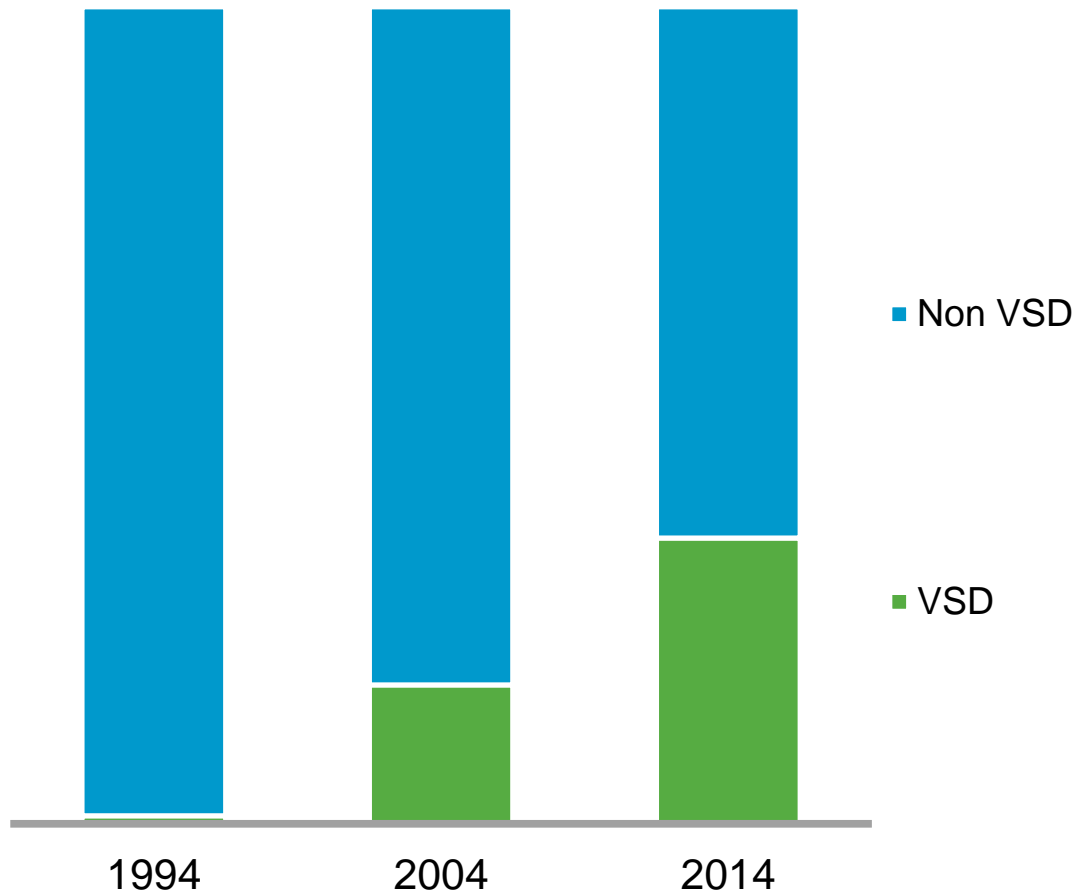

This development has led to a significant reduction in energy consumption



GA VSD⁺ – THE COMPRESSOR OF THE FUTURE

1994 – ATLAS COPCO PIONEERS THE VARIABLE SPEED DRIVE



- VSD = Energy saving of 35% on average
- Revelation in energy savings, total cost of ownership
- 1 in 3 oil-injected screw compressors sold by Atlas Copco is a variable speed drive

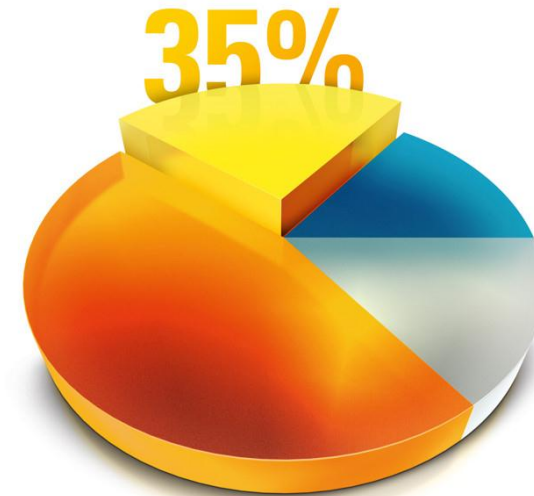

GA VSD+

- Unique drive system
- Integrated optimized solution
- Easy service

Footprint
-55%

Low noise
level:
62 d(B)A

Free air
delivery:
+13%

Specific
energy
requirement:
-50%



SMALL COMPRESSORS, BIG ACHIEVEMENTS

What if every oil-injected screw compressor sold in the world would be a VSD+?

- Average annual savings of 6 TWh
- Reduction of 3 million tons of CO₂
- Equivalent to 600 000 cars



ZH350+ TURBO DIRECT DRIVE

ZH350+ TURBO DIRECT DRIVE



No gears

- Atlas Copco designed direct drive high speed synchronous motor with frictionless magnetic bearings

No oil

- Not a single drop of oil inside

No losses

- ZH350+ the most energy efficient oil-free air compressor ever

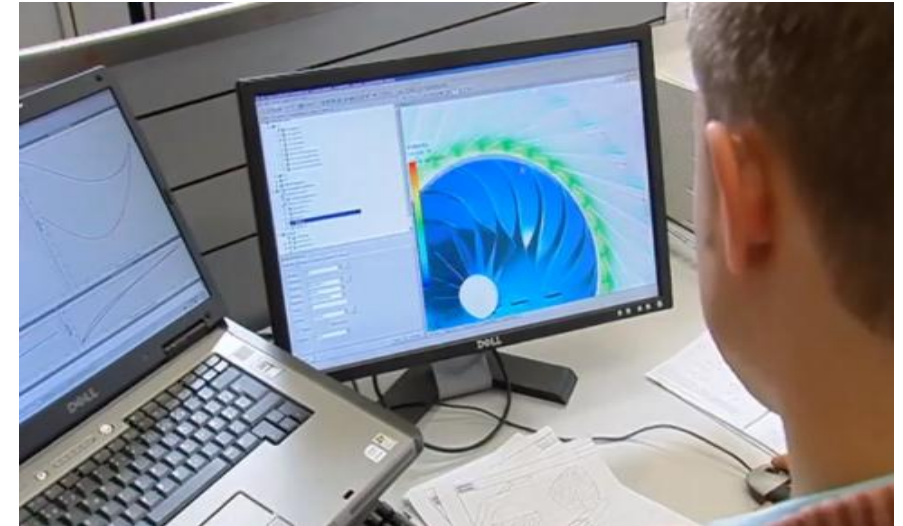

Computational fluid dynamics to increase energy efficiency by 6% and more

IXM DRY PUMP FOR SEMICONDUCTOR MARKET

IXM DRY PUMP



IXM
DRY PUMP

- 60% less power consumption than previous generation of dry pumps
- Increased lifespan
- 20% smaller footprint
- 2x lower noise than previous generation
- 30% lower weight than previous generation

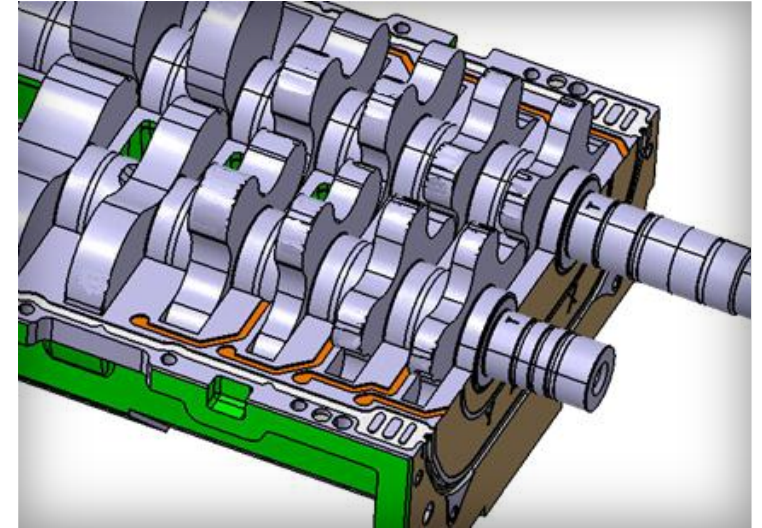

GHS VSD+ VACUUM PUMPS

GHS VSD+ VACUUM PUMPS

- Atlas Copco state of the art oil injected screw elements
 - Breakthrough efficient variable speed driven vacuum pumps
- Superior alternative to the traditional oil injected vane pumps:
 - Reduction in energy consumption – on average 50%
 - Silent technology, best in class noise levels
 - Clean operation: insignificant oil emissions
 - Compact all in one package with advanced controls
- Game changer in the utility vacuum segment
- Patented designs



SMARTLINK
COMPRESSOR DATA MONITORING SERVICES

A COMPLETE LIFECYCLE OFFERING



Genuine
parts



Customer
support plans



Air
optimization

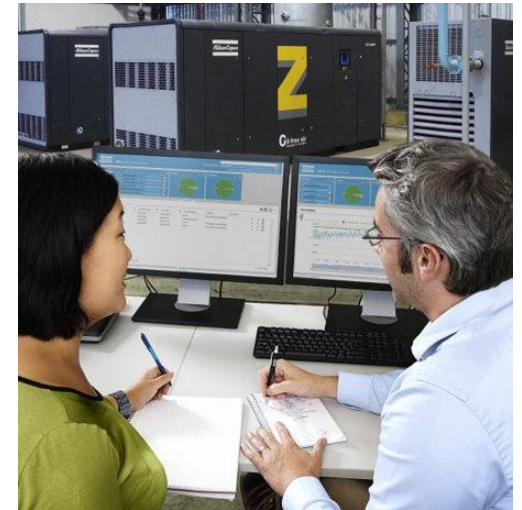

Monitoring
& control

SMARTLINK

- Connectivity as strategic differentiator
 - Monitoring running parameters
 - Investing in data → knowledge
 - Connectivity enables lower total cost of ownership

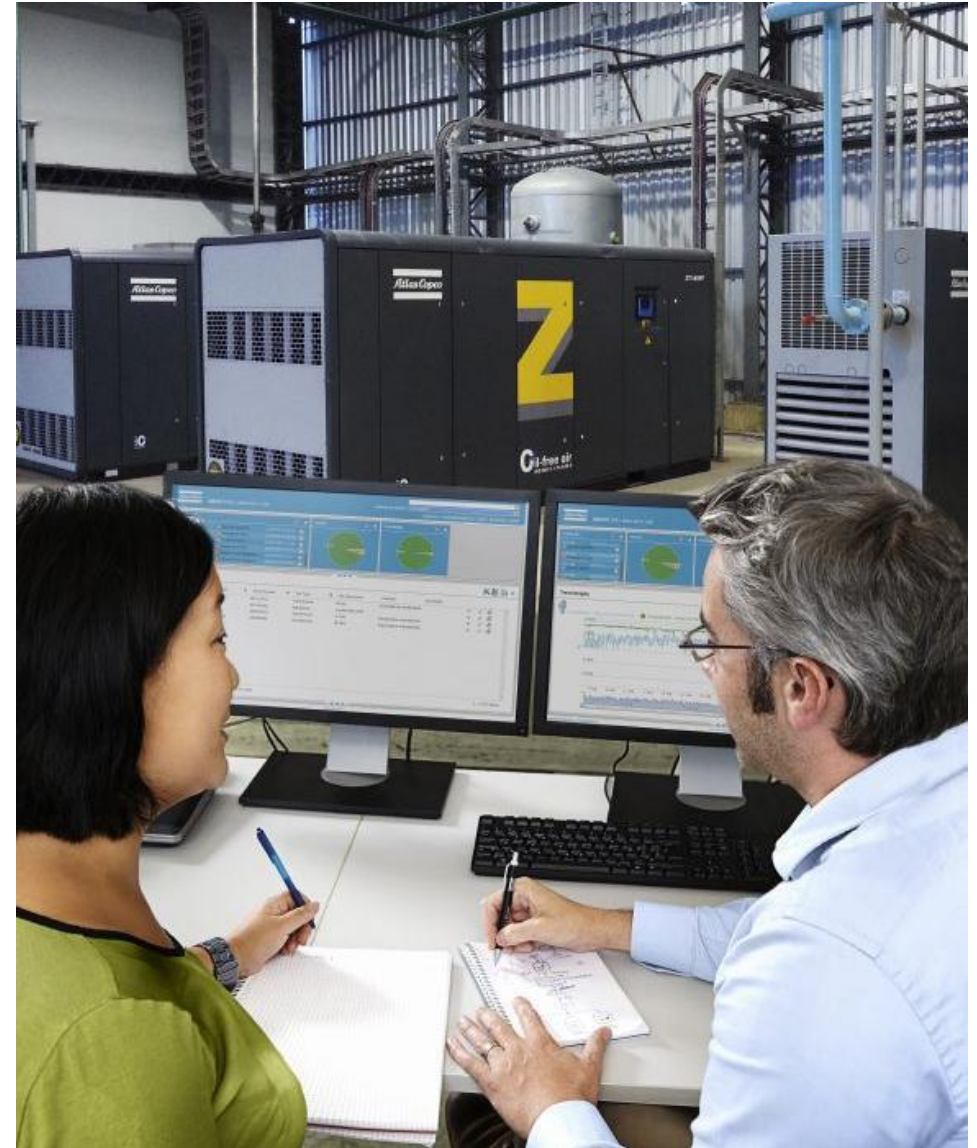

SMARTLINK

Operational Efficiency

- Service visits planned on actual running hours
- Pro-active service response towards customers



Customer Benefits

- Service on time
- SMS/E-mail warnings
- Energy consumption analysis



Maximum Productivity

Minimum Operating Cost

Product Development

- Running conditions and machine behavior identifies areas for product improvement



SUMMARY

Innovation is the
key differentiator
for market
leading position

The
organization is
strong and “fit
for more”

Innovation not
only in products



***COMMITTED TO
SUSTAINABLE PRODUCTIVITY.***



Atlas Copco

