

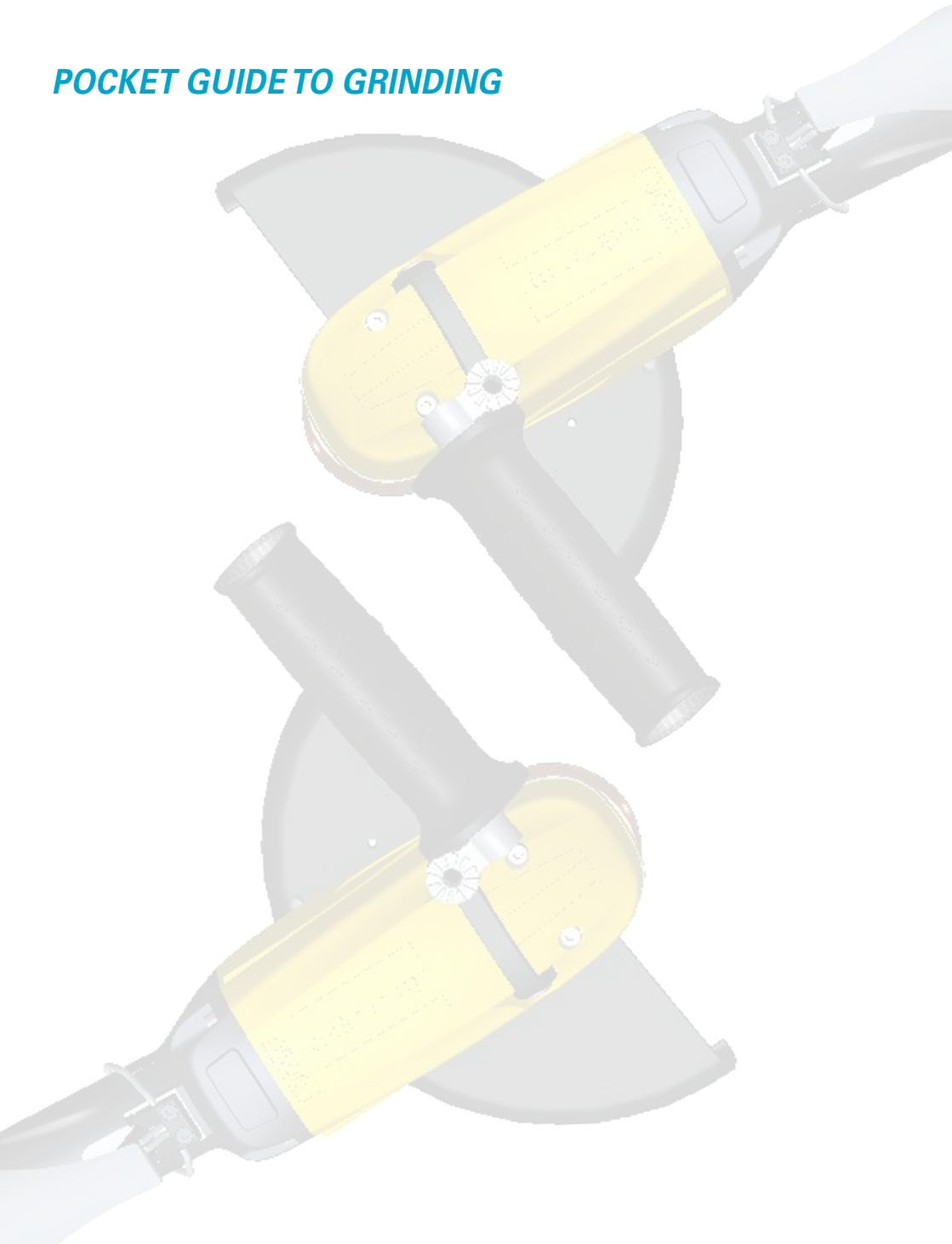

**POCKET GUIDE
TO GRINDING**

Atlas Copco

POCKET GUIDE TO GRINDING



CONTENTS

Chapter	Page
Introduction	4
Technical basics	6
Feed force	6
Power – Torque – Rotational speed	6
Peripheral speed	8
Abrasive agents	9
Grading	10
Three applications	11
Precision grinding (die grinders)	12
Rough grinding and cutting off	14
Surface grinding (sanders & polishers)	21
Reference table	
Tools and abrasives for grinding applications	30
Productivity and grinding economy	31
The importance of a correct air installation	34
The working environment	36
Tool weight and dimensions	36
Grip and working posture	36
Work rotas	37
Vibration	38
Dust	40
Noise	41
Safety	42
Atlas Copco grinders at a glance	44
Grinders for all applications	43
Selection guide: Applications and Atlas Copco models	45

INTRODUCTION

This is a guide to hand-held grinding. The information is mainly of a practical nature, intended for operators and others professionally involved with these tools. The emphasis is on grinding applications.

The guide covers these main areas:

- Technical basics
- Three applications
- The working environment

We begin by explaining some technical terms and the concepts that lie behind them. Three applications then form the heart of the guide. We look at:

- Precision or die grinding
- Rough grinding and cutting off
- Surface grinding (sanding and polishing)

This division is, we feel, the simplest way of presenting a complex subject.

For each application in turn, we describe why material is removed, the work done and the equipment used. We mention tool types, abrasives, and attachments and accessories. We also briefly discuss aspects such as settings and grinding technique. A reference table summarizes the main points.

We then look at productivity. We emphasize that good grinding economy is essential to overall productivity, pointing out how direct and indirect manpower costs dominate.

A brief review of the working environment follows. This highlights the value of good design and quality equipment in grinding, and thus for productivity. We focus on improved tool efficiency, operator comfort and safety. Aspects covered are tool weight and dimensions, grip and working posture, work rotas, vibration, dust, noise and safety.

The material so far is relevant to grinding equipment in general. It is then supplemented with specific information on the wide range of Atlas Copco grinders, and with reference to our tradition of ergonomic tool design. This section includes a selection guide chart and an illustration of tools in a typical working environment.

In conclusion, we look at the Atlas Copco Group. We mention how our knowhow and worldwide commitment are a continuous assurance of maximum grinding benefits: product performance and quality, backed up by know-how, training, distribution and service in over 130 countries.

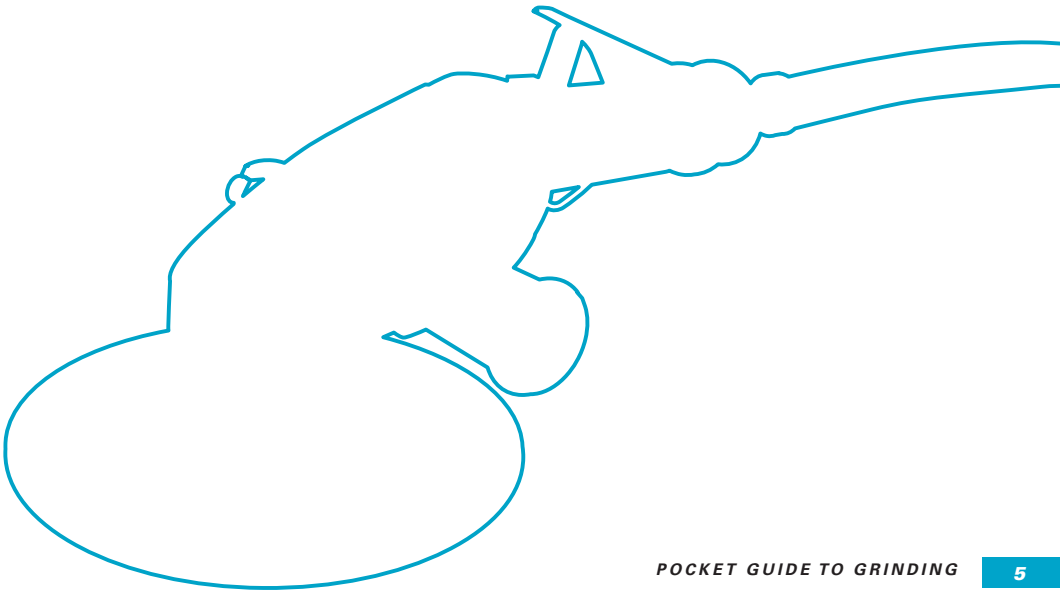

TECHNICAL BASICS



Figure 1

Feed force

People regard grinding in all kinds of ways. Operators usually want to get the grinding job over and done with very quickly as it can be unpleasant in the long run. The operator therefore tends to lean heavily on the tool, pressing it against the work surface in the belief that it will grind more effectively.

Up to a point, it does. Up to the limit of the tool's dimensioned power. Beyond that, excessive load or feed force (as the pressing action is called) is both inefficient and harmful to tool and operator alike. The power needed to grind can however be generated in other ways – and more efficiently.

Power – Torque – Rotational speed

Force is measured in Newton (N).

Energy is the capacity for doing work and refers to the energy generated or delivered; it's measured in Joules (J) or Nm (Newton meters). Power is the rate of doing work. Also called output or effect, power is defined as energy over time, usually per second; it's measured in J/s, Nm/s or W.

Power can also be described as the product of force and velocity. When velocity is applied in a rotating direction, power is seen as the product of torque and the rotational speed¹. Torque can simply be defined as force applied at the end of a lever (literally: the force applied in a turning direction).

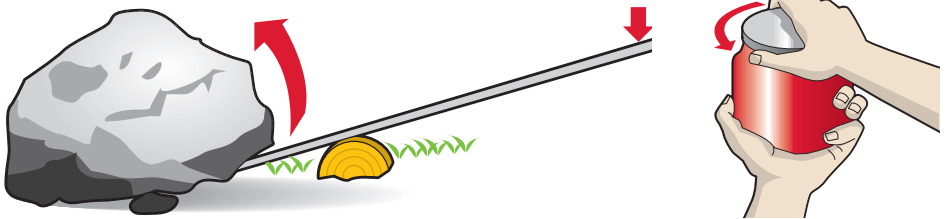

Figure 2

¹ Power (P) is equal to the product of torque (T) and rotational speed (n): $P = T \times n$. Torque is officially expressed in Newton x meters (Nm). The official SI-unit for rotational speed is radians per second (rad/s). In grinding the accepted term is, however, revolutions per minute (rpm).

When the abrasive is applied to the workpiece, rotational speed decreases as the abrasive is held back by the torque caused by grinding action and feed force. A great deal of the energy is lost through heat. The more feed force the operator applies to the tool, the lower the rotational speed.

For the simplest type of non-governed air tool, rotational speed is directly and inversely proportional to torque.

Air tools can however be made smaller and lighter by equipping the air motor with a governor. The governor limits the air flow through the motor when no torque is applied. As soon as torque is applied, rotational speed decreases and the governor permits more air to flow through the air motor. With this design, high output can be maintained at high speed.

The correlation between torque and rotational speed on a governed motor is shown in Fig. 5.

If a power tool is to be used optimally, the operator obviously needs to know which rotational speed gives maximum power.

A non-governed tool generates maximum power at 50% of maximum rotational speed (rpm). On a governed tool, this optimal point can vary between 75–90% of max rpm (also shown in Fig. 5).

However, it doesn't necessarily hold that optimal material removal always takes place at peak generated power. The grinding operation transforms power from the air tool into material removed plus heat. The optimum is in fact quite naturally the point when the feed force applied gives the most material removal and the least heat. At this point, power generated is used most efficiently. Grinding will therefore be most effective, provided the right type of abrasive is used.

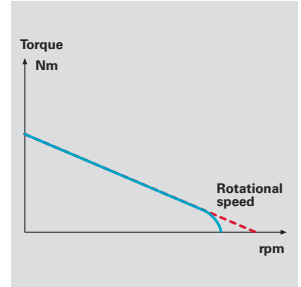

Figure 3

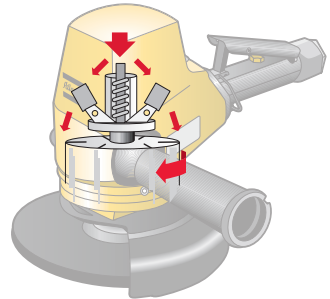

Figure 4

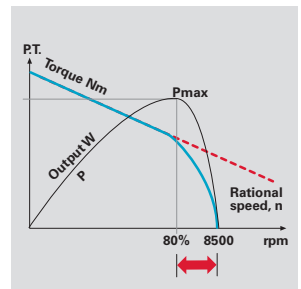

Figure 5

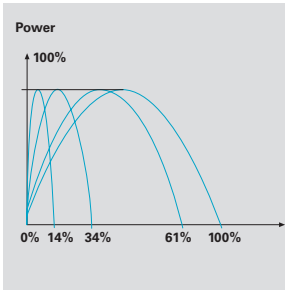

Figure 6

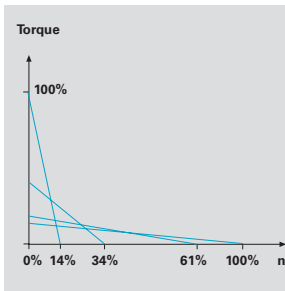

Figure 7

Gears can also improve power transmission from the air motor to the spindles, thus obtaining higher torque. The correlations between rotational speed and power and torque, respectively, using different gears are shown in Figs. 6 and 7. Note how each correlation gives symmetrical curves for all gears.

Peripheral speed

Peripheral speed is determined by wheel diameter and rotational speed. The correlation between wheel diameter and rotational speed is:

$$\text{peripheral speed (m/s)}^2 = \frac{\text{wheel diameter} \times \pi}{60} \times \text{rotational speed (rpm)}$$

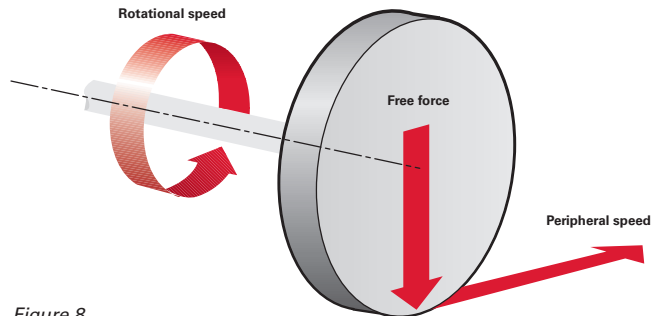

Figure 8.

All grinding wheels have a resistance threshold. If a grinding wheel shatters when rotating, the pieces that fly off can cause serious damage. Abrasives manufacturers therefore indicate on all their wheels both maximum peripheral speed and maximum rotational speed. These must never be exceeded.

² In the USA, peripheral speed is usually stated in surface feet per minute (SFPM).

Abrasive agents

There are several main types of abrasive, as will be described later: burrs, bonded and coated abrasives, wire brushes, polishing pads, etc.

The following refers to bonded abrasives (grinding wheels, etc.) and coated abrasives, where the abrasive or grinding agent consists of grit - small particles usually of aluminum oxide (Al₂O₃), or silicon carbide (SiC).

In bonded abrasives, the grains are bonded with phenolic resin or ceramics (vitrified wheels) to form a slightly porous mass of varying density. The abrasive mass can be reinforced with a fiber structure. Abrasive grains are also used in coated abrasives, with glue bonding (see page 21, Surface grinding).

Grain size and hardness of bonding (density or amount of resin) vary to suit the specific application and the surface required.

Fine grains give a smooth surface finish. They are also suitable for grinding sharp edges, removing a thin layer or for work on hard, brittle material and small objects. Coarse grains are more effective for large-scale material removal, for grinding tough material and large objects.

Softer bonding is usually suitable for fine grains and harder bonding for coarse grains, where feed force is often high and the main purpose is effective material removal.

Each specific application must of course be looked at separately. Grinding sharp edges for instance, naturally requires a hard bond that won't be worn out instantly. A softer bond is needed if the material being worked on is soft or malleable.

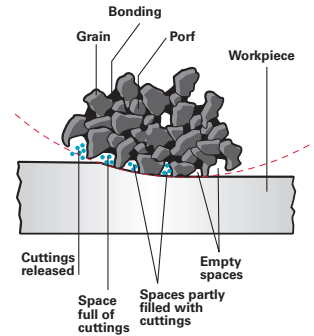

Figure 9

Grading

Abrasives are graded according to material composition, grain size and hardness of bonding.

The material composition of the grit is important, and is therefore indicated. Manufacturers often have their own branded variations with different mineral combinations. These almost always include:

Aluminum oxide (Al₂O₃) A
Silicon carbide (SiC) C

To grade by size, grains are sifted with increasingly fine-mesh sieves to determine which mesh size catches the grains.

Grain size is classified in an international standard (ISO 525). Size definition is mesh (meshes per inch):

coarse 8- 24 mesh
medium 30- 60 mesh
fine 80-180 mesh
very fine 220-400 mesh

Hardness of bonding is also classified, using the letters C–X. This classification is made individually at each company, which means that you can't compare the hardness of two discs from different suppliers by just comparing the letter.

very soft C-G
soft H-K
medium L-O
hard P-S
very hard T-X

Example:

A wheel for grinding forgings could be marked "A 24–30 O–R". This means medium-to-coarse aluminum oxide grains bonded with a medium-to-hard resin. The wheel is also marked with the maximum peripheral speed (80 m/s).

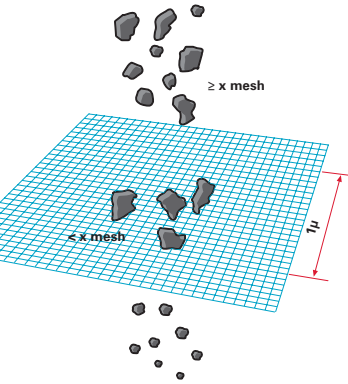

Figure 10

THREE BASIC APPLICATIONS

All manufactured products must to some extent meet surface finish requirements. The surface of basic materials, for instance sheet metal, is formed by the production process itself. When reshaping or reworking basic materials to produce a specific design, repair damage or otherwise improve the surface, material removal is the usual way of meeting these surface requirements.

Grinding is often used as a general term for all kinds of material removal with abrasive tools, regardless of the purpose of the operation.

It's certainly a complex subject, difficult to define since it covers many overlapping areas. In fact, the transition from grinding to sanding, cleaning and polishing is gradual, often with no clear-cut boundaries between.

But why are there so many types of tools; why different rotational speeds; and why the huge choice of abrasives in different materials and shapes?

It will probably help to take a step back and ask a much wider question to begin with: What's the main purpose of the grinding operation?

Studying all types of material removal with rotating tools would lead to an endless number of applications. Some kind of division into basic categories or applications is clearly needed.

Many different divisions are possible. All have something to be said for them. In this guide, we've chosen what we think is the simplest and most appropriate way.

Grinding is divided into three basic applications:

- Precision grinding (die grinders)
- Rough grinding and cutting off
- Surface grinding (sanders and polishers)

With this division, distinctions are made regarding grinding purpose, tool types, abrasives (grinding wheels, etc.) and their attachments, settings (rotational speeds, etc.) and grinding technique.

Precision grinding

Key aspects: small; high speed; precise or detailed.

Purpose

Precision grinding (more commonly, die grinding) with hand-held tools is done to remove material from small areas or spots, from cavities or other confined spaces. Creating cavities in a die and removing redundant material from narrow welds are typical precision or die grinding operations. Other operations requiring precision work include deburring cast or cut pieces of any material, e.g., beveling and grinding grooves.

Tool types

Die grinders are for precision work. They are ungeared, high-speed tools with a collet chuck. In the USA, they're often called collet grinders. Die grinders weigh about 1 kg. Compared with tools for rough grinding, they're fairly small and light, with limited output (up to 800W).

Straight (short/extended) or angle (angle-head) die grinders can be used. The choice depends on where the area to be ground is located and how the operator prefers to work.

Abrasives

• Burrs

The most common abrasives for die grinding are small burrs fitted on the tool with a collet and chuck (see opposite page, Attachments). Burrs are usually of tungsten carbide or sometimes high-speed steel, and are shaped in one piece around a steel shank. Another name for burrs is rotary files.

Burrs have teeth cut along the rotational axle, in a wide range from fine-toothed to coarse-toothed. They come in a great many shapes and sizes - cylindrical, ball-nose cylindrical, oval, flame and ball are typical.

The choice of burr depends on the job to be done. There's an optimal relation between burr head diameter and rotational speed (see opposite page, Settings). Tungsten carbide burrs usually give high material removal without being rapidly worn down. They are however relatively expensive to replace.



Figure 12

• **Mounted points and cone wheels**

These are also common abrasives for die grinders. They are however made of a solid abrasive mass - the abrasive material described in the opening chapter. They too must be attached to the tool (see below, Attachments).

Mounted points (or wheels) and cone wheels are also available in many different shapes. The purpose of the grinding operation determines the most suitable shape.

Abrasive agents

General information is given on page 6, Technical basics.

Attachments

Burrs are normally attached to the tool by a collet chuck. The burr shank is fitted into a collet which is then clamped with a chuck, as shown in Figs. 14 and 15.



Figure 13. Some typical burrs (from left): cylindrical, ball-nose cylindrical, oval, flame and ball

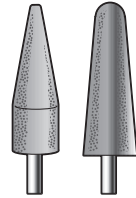

Figure 14

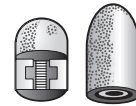

Figure 15

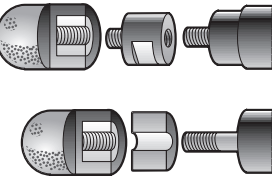

Figure 17

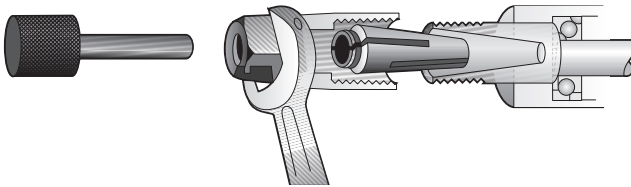

Figure 16. Collet chuck.

Mounted points are attached in the same way. Cone wheels have a female thread so they can be screwed or threaded on the tool spindle.

Settings: Rotational speeds

Speeds for precision grinding vary between 20,000 and 100,000 rpm depending on the material and shape of burr and workpiece. A finer, more precise operation requires a higher speed and a smaller burr. The correlation between burr head diameter and rotational speed is shown in Fig. 18 (valid for burrs only).

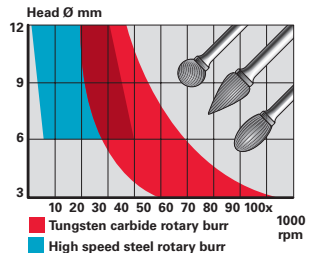

Figure 18

The operation to be performed determines the size of abrasive. This in turn determines the rotational speed. What remains is choosing the right level of power. Power requirements have to be set against increased weight and an often jerkier action.

The power rating for handheld die grinders is usually up to 800 W.

Technique

Every time a “tooth” of the burr or an abrasive grain touches the workpiece, it cuts out a chip. How big a chip depends on several factors: size of “tooth” or grain; hardness of the materials used; rotational speed and feed force.

The operator shouldn’t apply so much force that the bit jams and the tool stalls.

The surface area of the workpiece in contact with the abrasive should be kept as small as possible. Partly as this gives greater control over the tool; partly also to increase contact pressure, resulting in a higher material removal rate. Remember that rough treatment can easily damage abrasives. These, particularly die grinding burs, are expensive, so high burr consumption will affect grinding economy.

Rough grinding and cutting off

Purpose

The main aim here is effectively removing as much material (stock) as possible. Surface finish is of minor importance. Removing redundant material from cast, forged or welded pieces can involve leveling or smoothing edges and giving the piece the required shape. It can also mean removing material to form or enlarge a cavity.

Typical tasks are fettling castings, trimming welding joints or cutting off.

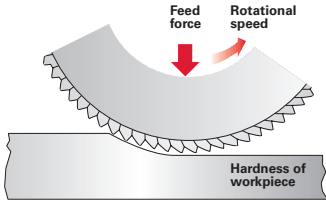

Fig. 19. Abrasive action using a carbide burr

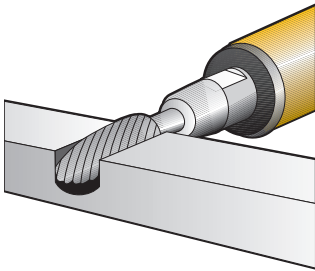
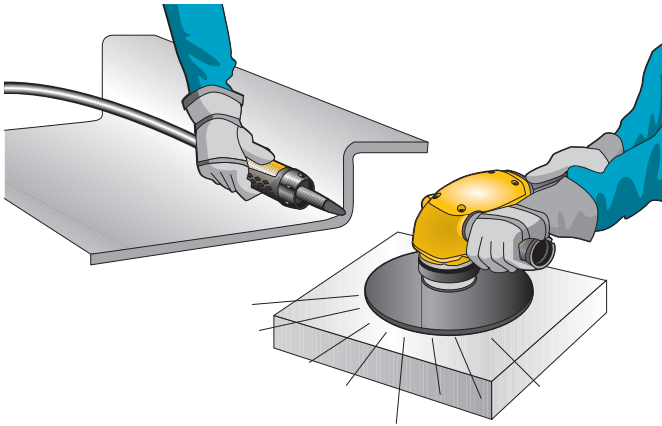

Fig. 20. Burr stuck in a cavity



Key aspects: power; size/weight; large amount of redundant material; rough/coarse materials; variety of abrasives (wheels).

Figure 21

Tool types

Rough grinders can be divided into vertical, angle, straight and geared turbine grinders.

Vertical grinders are usually used with depressed center wheels and cutting off wheels (Ø 180-230 mm). Comparatively big and powerful (1.4-3.8 kW), these are suitable for large-scale material removal where accessibility isn't a problem. On vertical grinders, the motor shaft and the protruding spindle are vertically aligned.

Geared turbine grinders are a new development. The design, based on turbine technology and a spur gear, gives a low-weight grinder with outstanding power (4.5 kW). Turbine velocity of 60,000 rpm is geared down to the desired grinding output speeds.

Geared turbine grinders are used mainly with depressed-center and cutting-off wheels (Ø 125-230 mm) or cup wheels (Ø 150 mm). They too are suitable for large-scale material removal. Tough surface grinding applications are also possible.

Angle grinders are also mainly used with depressed-center wheels and cutting-off wheels (Ø 80-180 mm). There is a 90° angle gear between the motor shaft and the protruding spindle driving the spindle. An angle grinder is therefore more suitable in confined spaces.

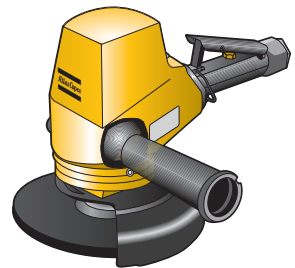

Figure 22. LSS 64

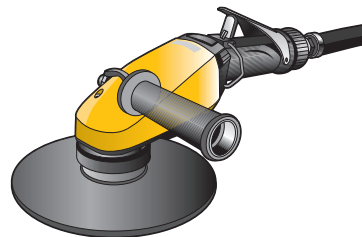

Figure 23. GTG 25

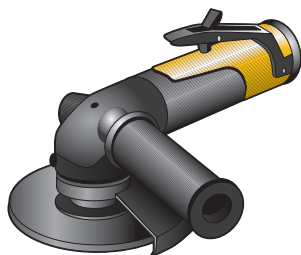

Figure 24. LSV 38

Straight grinders are used for grinding with either straight-sided wheels (\varnothing 50 - 200 mm), or mounted points and cone wheels (\varnothing 30-80 mm). The spindle is aligned with the motor shaft, as on vertical grinders. But as straight grinders are longer and slimmer, they can therefore get into narrow spaces or cavities.

Mounted points or cone wheels up to \varnothing 80 mm can be used without a wheel guard provided it's for internal grinding (to comply with EN68).

Choosing the tool

Many factors can determine the choice of tool. Major ones include the type of grinding work to be done; the workpiece - material, shape, and location to be worked on; the abrasive used; and the power required.

More power enables more material to be removed over time. However, this also means a heavier tool and higher air consumption.

Abrasives (grinding wheels)

Rough grinding and cutting off usually involve a bonded abrasive - a grinding wheel (also called a disc-wheel or disc). However, the range of coated abrasives now available includes many heavy-duty types, particularly nylon-coated, designed specifically for rough grinding or high material removal (see page 21, Surface grinding).

Grinding wheels can be divided into six basic types:

- depressed-center wheels
- cutting-off wheels
- straight-sided wheels
- cup wheels
- mounted points
- cone wheels.

The finished surface required and the material being worked on determine which is most suitable.

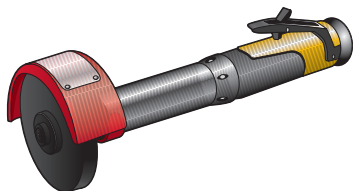

Figure 25. LSR 28

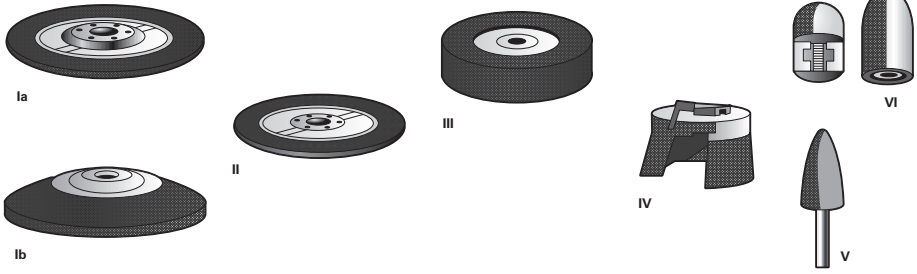

Figure 26. Six abrasives for rough grinding

- Depressed-center wheels (I) have a depressed center for full-flush contact of the wheel face without the attachments getting in the way. Depressed-center wheels are fiber-reinforced. In the USA, they're often known as raised-hub wheels, and two versions exist: ISO type 27/ordinary (Ia) and ISO type 28/"coolie hat" (Ib).

Normal dimensions: Ø 80-230 mm and thickness 4-10 mm.

- Cutting-off wheels (II) are flat, as the cutting is done with the edge and the wheel face is not applied to the workpiece. Also called cut-off wheels, they're fiber-reinforced, but are usually thinner than depressed-center wheels. (Some cutting-off wheels have a depressed center.) Normal dimensions: Ø 80-230 mm and thickness 2-3 mm.
- Straight-sided wheels (III) are used for material removal on open surfaces.
- Grinding is done with the circumference. There is more abrasive material in them than in depressed-center wheels so "straight" wheels don't wear out as fast.

Normal dimensions: Ø 50-150 mm and thickness 6-25 mm.

- Cup wheels (IV) are used for similar grinding tasks. The cup-wheel face does the grinding.

Normal dimensions: Ø 100-150 mm.

- Mounted points (V) and cone wheels (VI) are described above. These types are specially shaped for each operation, often internal grinding tasks. They also contain relatively more abrasive material than depressed-center wheels.

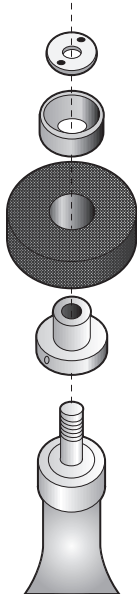

Figure 27. Flange assembly

Choosing wheel diameter and thickness, etc.

The main considerations when choosing wheel diameter are ease of use, machine speed and economy.

- Many operators prefer to use the smallest wheel possible; this is lighter and generates less torque when running.
- Apart from this, machine speed (rpm) is the single most important factor. Safety codes restrict maximum speeds – the larger the wheel, the lower the maximum speed allowed. (See opposite page, Settings.)
- Larger wheels also provide more usable wheel area (with abrasive material) at a lower additional cost.

Wheel thickness is also a question of cost-effectiveness. Thicker wheels give relatively more abrasive for the same price. A thinner wheel may sometimes, however, be better or even essential: e.g., when precision control is more important than material removal or when grinding must be done in confined spaces.

Abrasive agents

General information is given on page 6, Technical basics.

Attachments

Grinding wheels – depressed-center, cutting-off and straight-sided wheels (as well as cup wheels) – normally have a hole in the middle. There are prescribed standards for hole diameter in relation to wheel diameter and thickness. The wheel is placed between the two flanges and then clamped on to the grinder spindle. The whole package is held together by a nut.

The flanges are a very important part of the grinding system. They transmit force from the grinder to the wheel. Care must therefore be taken that the correct flanges are used for both wheel and tool. Flanges should also be regularly checked for any damage (burrs/flash, etc.).

Cup wheels are attached in a similar way, although they're clamped to the tool with a threaded insert against a flange.

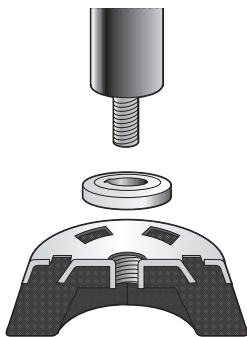

Figure 28. Cup wheel attachment

Mounted points have a shank or pin embedded in the bonding material. They are normally attached to the tool by a collet. The shank is fitted into a collet, which is then clamped with a chuck (Fig. 29a). This type is used mainly on straight grinders.

Cone wheels have a female thread so they can be screwed or threaded on the tool spindle (Fig. 29b).

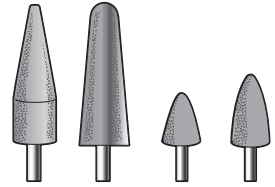

Figure 29a. Mounted point

Settings: Peripheral and rotational speeds

Grinding is most effective when it’s done at the grinding wheel’s maximum peripheral speed. The faster the abrasive travels over the surface of the workpiece, the more grains will come into contact with its surface in a given period. The wheel can therefore remove material more effectively.

All grinding wheels, no matter how resistant, have their limitations. If a grinding wheel breaks when rotating, the pieces that fly off can cause serious damage. Abrasives manufacturers therefore indicate on all their wheels both the maximum peripheral speed and the maximum rotational speed. These must never be exceeded.

If the peripheral speed only is indicated, the rotational speed for that given wheel must be determined accordingly. Don’t always use the same rotational speed regardless of wheel. Peripheral speed is determined by wheel diameter and rotation speed. (See page 6, Technical basics,)

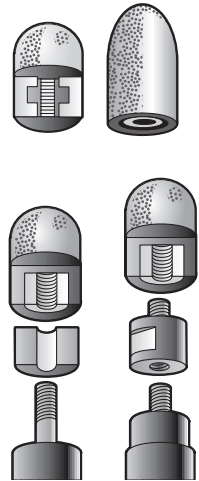

Figure 29b. Cone wheel

Maximum peripheral speeds (to comply with FEPA and ANSI safety codes):

	FEPA	ANSI (USA) ³
Reinforced depressed-center, straight-sided and cutting-off wheels 180 mm; 8,500 rpm 230 mm; 6,600 rpm	80 m/s 7"; 7,750 rpm 9"; 6,000 rpm	72 m/s
Cup and straight-sided wheels	50 m/s	48 m/s (high-strength wheels)
Cone wheels	50 m/s	48 m/s (high-strength wheels)
Vitrified wheels	35 m/s	33 m/s (high-strength wheels)

Table 1

³ In the USA, peripheral speed is usually stated in surface feet per minute (SFPM).

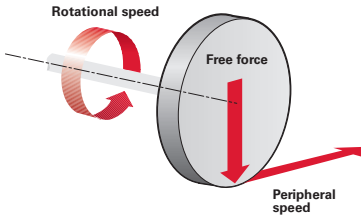
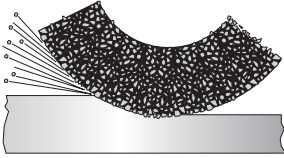

Figure 30

Geometrically non-determined



Geometrically determined

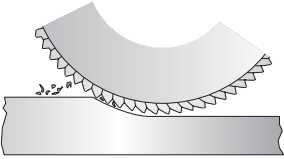

Figure 31

A normal rough grinding job will involve grinding with a 180 mm depressed-center wheel at 8,500 rpm (peripheral speed 80 m/s).

Technique

When grinding with handheld tools, the pattern, sequence or actual shape of the material removed can't be calculated or determined beforehand. Such grinding operations are therefore said to involve material removal that is "geometrically non-determined." This is not so, for example, in grinding with stationary machine tools.

Each grain removes a chip of material when touching the surface. Geometrically non-determined grinding doesn't however create a track (grindline) as deep as the wheel is thick. Although hard, the grains are eventually worn out and lose their sharpness, and therefore their abrasive property.

When the correct wheel is used, the grains will either snap off or break loose from the bonding agent as soon as they're no longer sharp enough to remove any more material. Fresh grains with sharp edges are constantly exposed, and form a new cutting surface for material removal. Self-sharpening in this way is important for effective grinding.

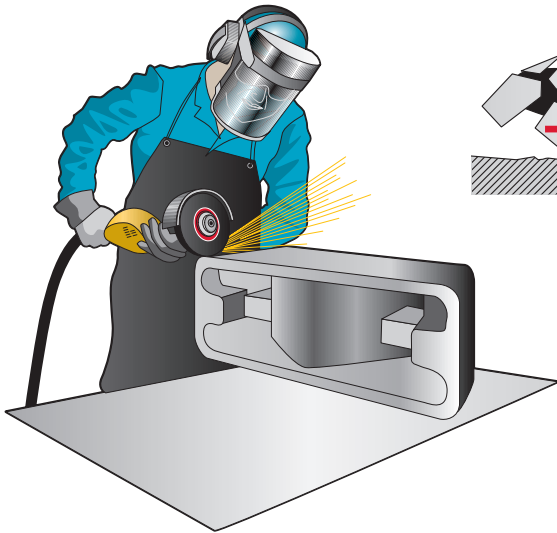
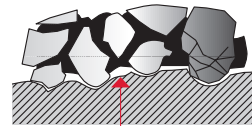
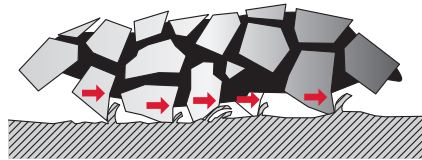
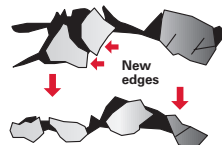

Figure 32. Rough grinding with straight wheel



Contact
Rounded grain edges



Grinding done with a rocking movement will help this process as it lets different parts of the wheel face (or cutting edge) touch the workpiece surface. When cutting off, this rocking movement should follow the rotating direction of the wheel.

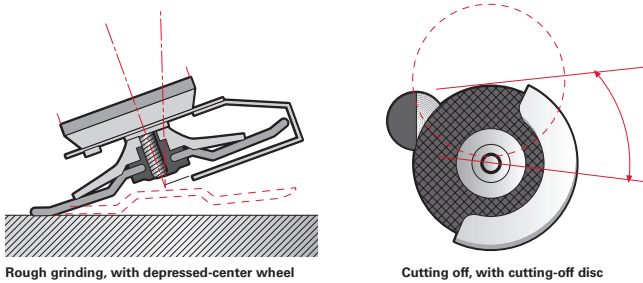

Figure 33

Surface grinding (sanders and polishers)

Purpose

We've noted that in rough grinding especially, surface finish is far less important than the amount or rate of material removal itself.

In surface grinding applications, much more attention is paid to surface quality. Main examples are sanding, cleaning, light deburring, polishing and finishing.

Such operations are sometimes also referred to as surface conditioning. This term should perhaps be restricted to operations to improve the surface without changing the basic shape or dimension of the workpiece. In other words, such material removal should be minimal and reasonably uniform. Surface grinding also usually involves working in several stages.

Surface grinding applications: some examples			
Sanding	Rough sanding Fine grit sanding	Polishing	Grindline conditioning Reducing surface roughness Weld polishing Paste buffing
Cleaning	Corrosion removal Paint removal Rubber removal Weld cleaning	Finishing	Wet and dry refinishing
Deburring	Edge radiusing and burr removal Flash removal Surface burr removal		

Table 2

We've also pointed out earlier that there are few hard and fast divisions in material removal. It covers a broad spectrum of related applications with gradual and often subjective transitions between, say, grinding and sanding, etc.

This overlap can be seen in the equipment and techniques used. For example, sanding with abrasives such as flap-wheels or coarse fiber-discs (using a vertical grinder) can often remove as much material as in rough grinding, but leaving a much better surface.

Every surface, when magnified under a powerful microscope looks like a cross-section of a mountain landscape. To obtain a smoother, more even surface, the contours have to be removed – the "peaks" leveled.

This can be done by rubbing an abrasive back and forth over the surface (as in grinding proper, only covering a larger area instead of concentrating on a spot).

When a very smooth surface is required, using a liquid is an effective, low-friction way of removing the 'spent' grains and rubbing the surface finer. The liquid acts as a coolant. The highest gloss can be obtained by polishing an already smooth surface. A paste with abrasive additives can be applied using a soft bonnet or mop.

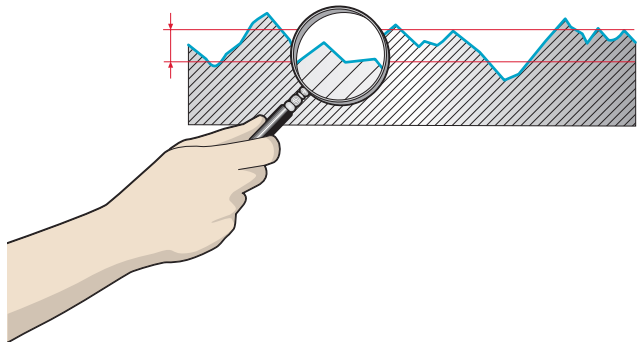

Figure 34

Key aspects: large surface area; different rotation principles; lower speeds; multi-stage work; liquid; paste with additives.

Tool types

The tools used for surface grinding can have either a rotary, orbital or random orbital mode of action.

Rotary: A simple rotating action, axial or radial, used in all the grinders described so far.

Orbital: The pad makes small eccentric movements (oscillations) setting the grains in motion to rub off the edges of the uneven surface.

Random orbital: A superimposed rotating movement is produced during every orbital rotation. This combination creates an orbital movement that also moves in circles (swirls). Sometimes called dual action (DA).

Some of the grinders we've already discussed are also used as rotating sanders. These can be either vertical, geared-turbine, angle or straight tools.

Vertical and **geared-turbine** tools are used for rough sanding, usually with coated abrasives or brushes.

Angle (angle-head) tools are for lighter sanding with coated abrasives and polishing with a lambswool bonnet.

Straight tools are slow-speed die grinders for light sanding and fine polishing (with collet attachments to hold shaped abrasives with shanks, e.g., flap-wheels and nylon-coated abrasives).

(Surface-grinding abrasives are described on the next page.)

Orbital and **random orbital** tools are differently designed to produce a mode of action that's oscillating instead of purely rotary. The protruding spindle is in both cases aligned with the motor shaft. The difference being that on random orbital tools an eccentricity is built in between spindle and motor.

Orbital and random orbital sanders are for finishing work with coated abrasives. They have a one-handed or two-handed grip. Random orbital tools are often used on surfaces that need to be given a smooth finish quickly.

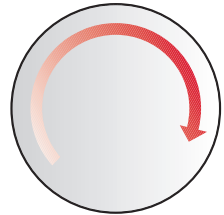

Figure 35a. Rotary (axial)

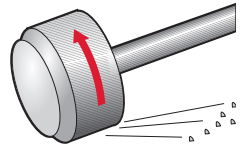

Figure 35b. Rotary (radial)

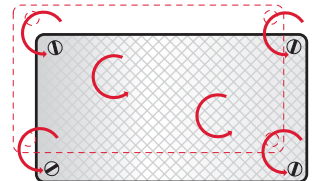

Figure 36a. Orbital

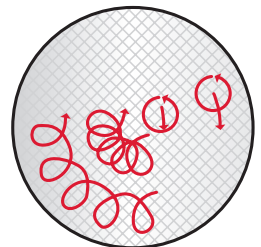
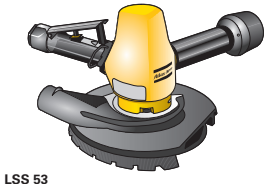
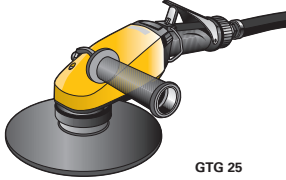

Figure 36b. Random orbital



LSS 53



GTG 25

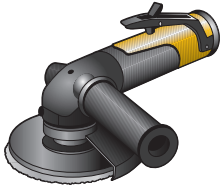

LSV 38 with wet sander

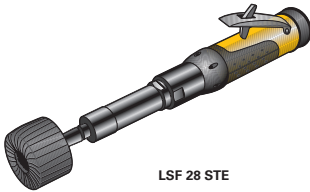

LSF 28 STE

Figure 37. Vertical, geared-turbine, angle and straight sanders

Abrasives

The usual abrasives for surface grinding are called coated abrasives. There's a wide and growing range on the market, with different types, shapes, sizes and qualities. Different component combinations produce varying properties to suit all applications; even rough grinding and fine polishing.

Coated abrasives are usually in sheets or as discs, both attached to backing pads. There are also versions shaped around a hub or shank. Flap-wheels are an example. These are strips of coated abrasive radially attached to a cylindrical hub, either solid and shaped around a shank, or hollow. Flap-wheels are for grinders with a collet chuck (die grinders/straight tools).

Coated abrasives are flexible and consist of a backing, a bonding agent (basic-layer glue and upper-layer or cover glue) and an abrasive agent (grains). A standardized product code identifies the components used.

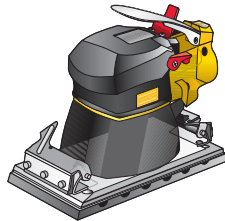

LSO 30

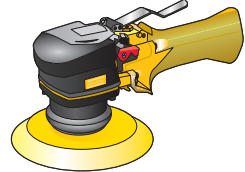

LST 30

Figure 38. Orbital and random orbital sanders

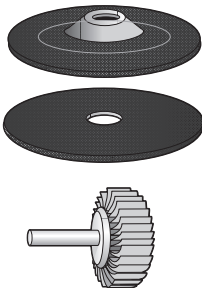

Figure 39. Coated abrasives; fiber disc and flap-wheel

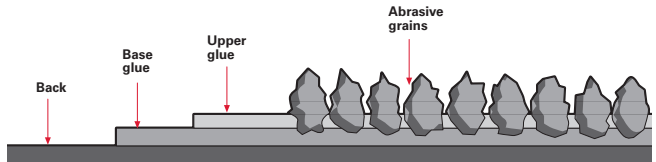

Figure 40. Composition of sanding abrasives abrasive grains, upper-layer glue, basic-layer glue, backing

- **Backing**

Backing can be of several different materials, including composites. The three main types are:

- paper
- woven fabric
- fiber

Paper-backed abrasives are available in different thicknesses and degrees of flexibility.

Woven fabric-backed abrasives are used for rough sanding with powerful tools.

Fiber-backing is used on discs. Fiber is especially flexible and durable, and therefore suitable for really tough sanding operations.

- **Bonding agent**

The bonding agent on coated abrasives is glue. These are of two main sorts: glue coating and phenolic glue.

Glue coating gives a flexible, not too aggressive abrasive which can be used dry or in combination with oil. Phenolic glue is more resistant and durable. Phenolic glue abrasives remove material more effectively and can be used dry or in combination with oil or water.

- **Abrasive agent**

General information is given on pages 6 – 7, Technical basics.

Nylon-coated abrasives (coated textiles)

Applications for finer surface conditioning (polishing, finishing, etc.) require a different type of abrasive: flexible and soft enough to improve the surface finish without deforming the workpiece or changing its dimensions. Depending on the workpiece and the quality of finish required, the main materials in use are lambswool bonnets and nylon-coated abrasives (e.g., Scotch-Brite or other brands).

The latter are also called coated textiles. They're non-woven synthetic fibers and abrasive grains, bonded with polymer resins to form a resilient, open web material.

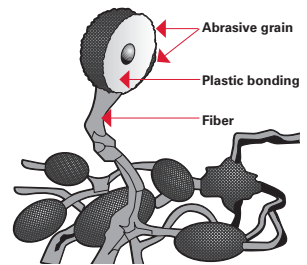

Figure 41

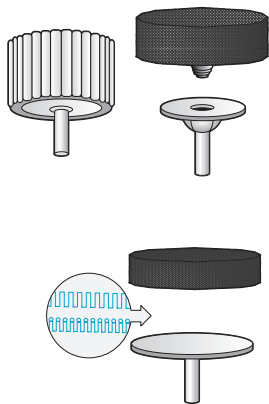

Figure 42

The trend is definitely towards nylon-coated abrasives. Strong growth has led to extensive product development, with a wide range now on the market. There are in fact products for all operations, even rough grinding.

In surface applications, they're a perfect follow-up to surface grinding with coated abrasives, which tend to mark the surface. Lambswool bonnets, felt mops and foam rubber are used for final soft buffing or polishing to obtain a high-gloss finish.

Brushes

Brushes are traditional tools for corrosion and paint removal, cleaning and other forms of surface grinding. Wire (including stainless steel), nylon (often impregnated with abrasive particles), and natural fiber are the most common materials in use. The material can be formed in various patterns.

Wide brush diameter, and short coarse tufts will all give effective surface grinding, but with a less smooth finish. A fine, smooth and even surface is easier to produce using long, fine tufts on a broad-banded brush.

Axial (cup-type) brushes are suitable for heavy-duty tasks and large surfaces; radial brushes are used on straight grinders, for work in confined spaces, internal surfaces, etc.

Attachments

Surface-grinding abrasives are either backed by a pad or shaped around an attachment shank.

There are backing pads of different materials and varying stiffness. A stiffer pad is used when more feed force and a coarser abrasive are needed. Softer pads combined with fine abrasives or polishing cloths give a smoother surface with better finish.

There is either a hole in the middle of the pad or a shank embedded in it. The hole-type are attached to the spindle of a sander and clamped with a nut. The shank-type (spindle pads) are clamped in a collet chuck. (See above). There are also threaded versions of both types.

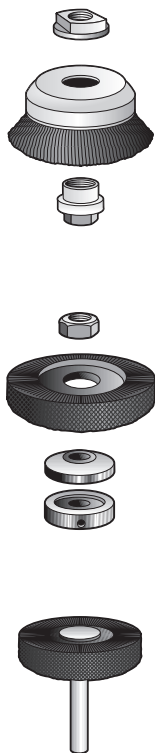
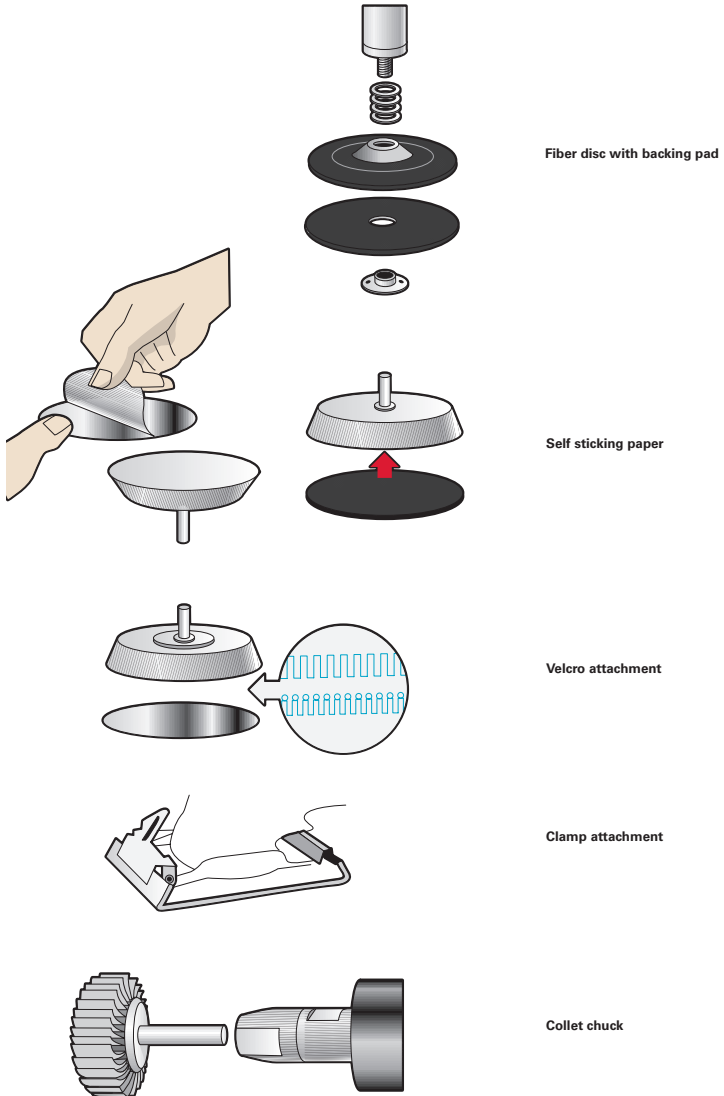

Figure 43. Axial brushes, radial brushes

There are special pads for self-adhesive (self-sticking) and velcro abrasive papers.

Brushes are either attached to the spindle by flanges and a nut or threaded directly on the spindle.



Fiber disc with backing pad

Self sticking paper

Velcro attachment

Clamp attachment

Collet chuck

Figure 44

Settings: Rotational speeds

The same basic grinding principle applies also to surface applications. Coarser abrasives and higher speed remove more material.

Contact at high speed between the abrasive and surface spreads the feed force over a larger area and more grains, which therefore retain their sharpness and stay attached to the backing longer.

The speed shouldn't be so fast that the grains don't really penetrate the cracks or hollows. If this happens, only the topmost edges will be removed and the surface will not be totally smooth.

The challenge is to find the right balance between distributing the feed force over a wider area (high speed) and making sure the abrasive gets down into all the cracks (lower speed).

This is done by setting the correct operating speed based on several factors:

coarseness and flexibility of abrasive, shape of backing and whether a liquid coolant or paste is used.

Normal rotational speeds are:

Dry sanding	4 000 – 6 000
Polishing with a lambswool bonnet (with or without paste)	1 300 – 2 100
Wet sanding	300 – 1 800

Table 3

The maximum rotational speeds for nylon-coated abrasives must never be exceeded as the synthetic fiber may melt.

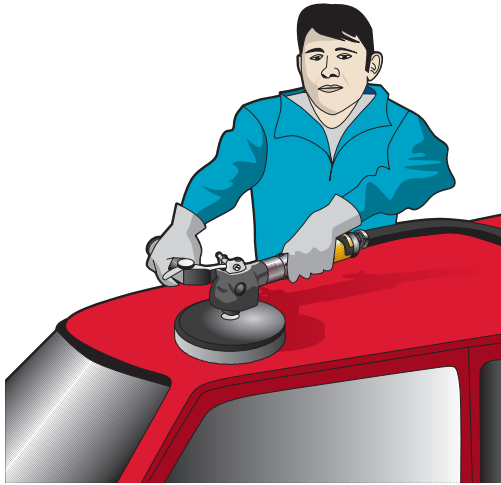

Figure 45. Wet sanding

For LSV 17, the following speed and dimension of the abrasive disc is recommended:

LSV 17	Peripheral speed of the disc	
	20–30 m/s*	40–60 m/s**
8 000 rpm	Ø 40 – 60 mm	Ø 80 mm
12 000 rpm	Ø 32 – 50 mm	Ø 60 – 80 mm
20 000 rpm	Ø 20 – 30 mm	Ø 38 – 60 mm

Table 4

* coated abrasive e.g. Speed-Lok from Norton.

** nylon-coated abrasive e.g. Roloc from 3M.

Wet sanding or polishing at higher speeds tends to splash liquid out to the edge where it can't do its job properly.

Technique

To get a smooth, even surface, the pad or abrasive should never be kept still at one spot during surface grinding. If it is, the abrasive tends to dig itself into the material and the surface will not be satisfactory.

The feed force should be continuously adjusted to the rotational speed, which should be kept at 60-80% of the maximum rotational speed of the tool.

When the surface has been made as smooth as possible with a coarse coated abrasive, a finer quality or a nylon-coated abrasive can be used for finishing.

REFERENCE TABLE

Tools and abrasives for normal grinding applications

Grinding applications	Grinders					
	Die grinders	Vertical grinders	Geared turbine grinders	Angle grinders	Straight grinders	Sanders
Die grinding with:						
• rotary burr	•					
• mounted point	•					
Rough grinding with:						
• straight-sided wheel					•	
• depressed-center wheel		•	•	•		
• cup wheel		•	•			
• cutting-off wheel		•	•	•		
• mounted point	•					
• cone wheel					•	
Surface grinding with:						
• coated abrasive, dry sanding		•	•	•		•
• coated abrasive, wet sanding				•		
• nylon-coated abrasive	•	•		•		
• lambswool bonnet, etc.				•		
• wire brushes		•	•			

Table 5

PRODUCTIVITY AND GRINDING ECONOMY

Manpower and abrasives together account for about 90% of the total cost of grinding with handheld equipment. Wages alone make up the major part of manpower costs: often as much as 80%, or nearly half of total costs. Time is definitely money.

In other words, the time taken to complete the grinding task is crucially important. Reducing this time will lead to increased productivity and cost savings.

The main factors affecting grinding time are:

- Grinder output
- Feed force
- Operator stress and physical strain
- Time spent replacing worn abrasives
- Accessibility.

Grinder output is vital for high material removal, and is thus probably the single most important factor in total grinding economy. Yet actual performance that really exploits full grinder output or power, requires high feed force and good operator technique.

This, in turn, presupposes the correct use of quality abrasives for maximum material removal and minimum wheel wear. The ratio of material removal to abrasive wear depends on the right choice here. Based on the materials involved and tool output, it's possible to work out in advance which abrasive is needed.

There is therefore a direct correlation between good overall grinding economy and the right choice of equipment: quality tools and abrasives suited to the job in hand. This equipment should be seen as an investment in long-term productivity, not as a short-term cost. Ergonomic tool design can greatly contribute to this.

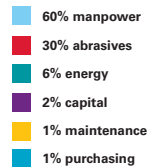
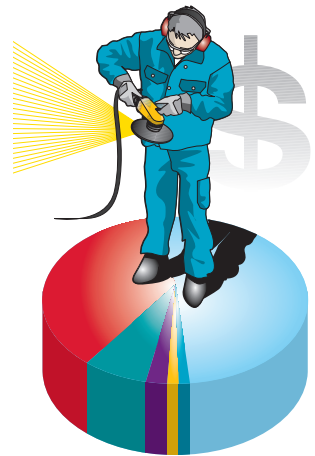

Figure 46. Grinding costs

The benefits in productivity gained by an operator working efficiently with an effective and ergonomically well-designed grinder far outweigh the additional expense of the tool's higher purchase price. As noted above, capital expenditure and related costs are marginal compared with the cost of manpower and abrasives.

Replacing worn abrasives is time "wasted" for effective grinding. The amount of time lost depends on the rate of abrasive wear and the ease of changing abrasives. Both of these are also connected with the choice of quality equipment. Good grinder design can often appreciably reduce abrasive wear.

Low-quality abrasives have inferior geometry and composition: out-of-roundness, skewness, imbalance, uneven density, etc. They wear out more quickly, giving lower material removal; they generate higher vibrations and cause other time-consuming problems affecting the operator and the grinding process.

The extra costs involved in frequently changing such abrasives – both the time wasted and the cost of abrasives – are far greater than the savings made on the lower price of these abrasives compared with high-quality products. Total production costs are higher.

Accessibility can also affect productivity. Grinding inaccessible surfaces or in cramped, confined spaces is quicker and easier with small, lightweight tools, provided they are powerful enough.

Increased productivity %	Effective grinding time per day*	
	1 hour	3 hours
	Reduction in grinding hours per month	
20	4	12
30	6	18
40	8	24

Table 6

* Average effective grinding time is typically 40%, e.g., 3.2 hours of an 8-hour day.

The cost of energy is one of the smaller costs in the grinding operation. When high frequency (HF) grinders are installed, the energy cost is usually lower than in the case of air grinders. HF grinders are, on the other hand, less productive than modern turbine grinders. Their rated power is usually 50% lower than that of the turbine grinder and they are usually twice as heavy. In the long run, they are therefore less comfortable to work with. Annual repair and maintenance costs usually vary between 30-100% of the cost of the grinder itself.

THE IMPORTANCE OF A CORRECT AIR INSTALLATION

A correct air installation is essential to the correct functioning of your grinder and the productivity of your grinding operation. Having selected the grinder for your grinding job, some additional effort must be spent on the air installation. The grinder needs 6.3 bar to operate at rated power. Decreasing the operating pressure by 1 bar leads to a productivity loss of 25-30%. The example below shows the results from a test performed at Atlas Copco and how the productivity decreases due to decreased air pressure.

Working pressure	6.3 bar	5.8 bar	5.0 bar
Material removal	5.5 kg / h	4.5 kg/h	4.0 kg/h
Time to remove 1 kg	11 minutes	13 minutes	15 minutes

Table 7

How do I ensure 6.3 bar at the grinder ?

In the network, between the compressor and the tool, there are pressure losses due to friction in the pipe restrictions, bendings and pipe walls. The main pressure drop occurs in the part between the pipe end and the tool, i.e., the shut-off valve, the air preparation units, the couplings and the hose. The pressure drop of these components should be kept as low as possible to ensure high productivity and energy savings. The pressure drop in this part should not exceed 0.6 bar. Reaching 6.3 bar at the tool end then requires 6.9 bar at the network end and this of course demands that the plant has a compressor of sufficient capacity to compensate for the pressure drop in the air net.

How do I choose the air line accessories?

Pressure and flow follow each other so you obtain different flow at different pressure drops. Atlas Copco recommends air preparation units, hoses and couplings at determined flows, (stated in catalogue), corresponding to 0.2 bar pressure drop and a 5 m long air hose.

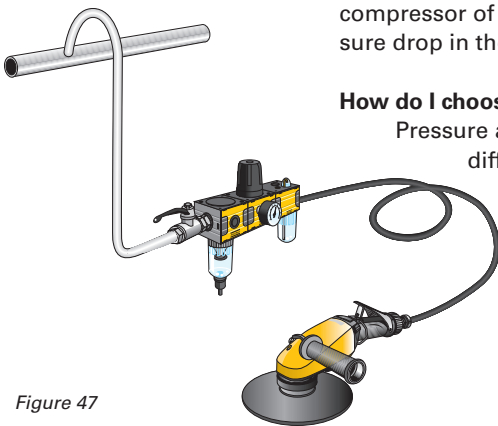

Figure 47

The procedure for choosing air line accessories is:

- find out the air consumption at full power of the grinder
- choose a suitable air hose that has a max. recommended air flow that is equal to, or exceeds the air consumption of the grinder, use a rubber hose for rougher work and outdoor operations
- if the air hose needs to be 10-15 m, increase hose size by one size, e.g., from 13 to 16 mm. If hose length is 20 m, increase hose size by two sizes, e.g., from 13 to 20 mm.
- choose suitable couplings and nipples according to hose size and airflow
- choose suitable air preparation units according to air flow capacity and grinder, (if lube-free - no lubricator.
- choose correct size clamps, (worm drive for grinders).

This procedure can be simplified by ordering a recommended air preparation kit and a hose kit intended for your grinder. You will find the appropriate Installation Proposals in the Atlas Copco main catalogue, Air Line Accessories catalogue and the General Engineering catalogue. See also our "Pocket Guide to Air Line Accessories"

THE WORKING ENVIRONMENT

As we mentioned before, there's an unpleasant side to grinding jobs, especially long, uninterrupted stretches of rough or monotonous grinding. The operator can often be exposed to vibrations from the tool, noise from the process and tool, dust, etc. If not controlled or remedied, these problems will adversely affect the operator and productivity. The working environment is not always optimal, and this is increasingly seen as wasteful and counter productive. More and more attention is being paid to improving tool design and operator techniques.

Developing better grinding tools cannot improve all aspects of such work. However, efficient and reliable tools are a good start: tools designed with people in mind, and used properly in a good working environment.

A good environment has several basic features:

- Tool weight and dimensions
- Comfortable grip and working posture
- Balanced work rota (task rotation)
- Low vibration levels and exposure time
- Dust extraction
- Low noise levels

Tool weight and dimensions

Material-removal properties improve with added weight. Mass also lessens sensitivity to vibrations. However, there's a direct trade-off between these advantages and their inconveniences. The operator must be able to maneuver the tool easily while working, without tiring too quickly. Bulky tools will restrict work in confined spaces.

Grip and working posture

These are also important features of ergonomic design, ensuring that the operator can work comfortably and efficiently without undue strain.

Handles and triggers should be designed to give a natural hand grip – this is always the most comfortable. It should also be easy for the user to change grips as this helps distribute

the load and avoid local muscular fatigue. Women operators are usually more comfortable using a slimmer handle (Ø 34 mm instead of 38 mm).

Most grinding tools are held with a two-handed grip on the handle (or handles) for stability and even load. On sanders, a palm-grip is also possible. Operators usually have a personal preference.

A straight grip is possible on straight tools (die grinders and straight grinders), as the tool casing is the handle. Here a smooth casing surface would become slippery; the surface should instead provide enough friction for a firm grip.

The lever trigger is used on almost all grinders and sanders. This is easy to control and produces less strain. The tool cuts out as soon as the lever is released.

Working posture may seem self-evident, but using the right type of tool can help you work in a natural way – one that feels comfortable and less tiring.

Work rotas (task rotation)

The work situation is greatly improved by letting operators alternate between grinding operations and other tasks. A balanced work rota will reduce the effect of overload, repetitive strain and awkward posture. It will also cut the time operators are exposed to vibrations.

In a foundry for instance, tasks such as handling the melt, making cores and deburring are often carried out close to each other. A work rota where each operator deburrs castings for a few hours a day only and works on other tasks the rest of the time brings clear benefits.

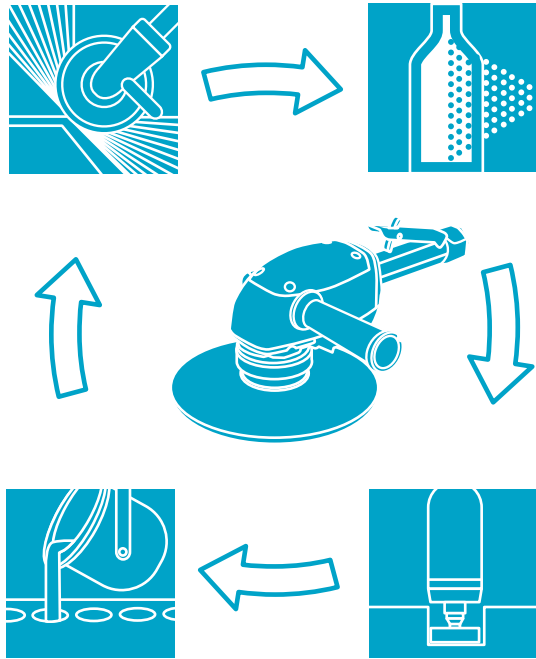

Figure 48. Work task rotation

Vibration

The vibration involved with grinders is a problem. This is an important, complex subject that cannot be covered in detail here. The brochure “Vibrations in grinders” contains more information.

Causes of vibration

The periodic (recurring) forces involved can be generated in several ways, and many different factors combine to cause vibration.

Vibrations in grinders are mainly the result of imbalance in the abrasive, most commonly a grinding wheel of some kind. Even the tiniest deviations in wheel geometry (<0.1 mm) can cause imbalance.

The hole in the wheel may be out of alignment (out of true); or the hole’s axis may not be perpendicular to the plane of the wheel; or an uneven gap remains between the wheel and the tool spindle. A wheel of uneven thickness or density can also cause imbalance.

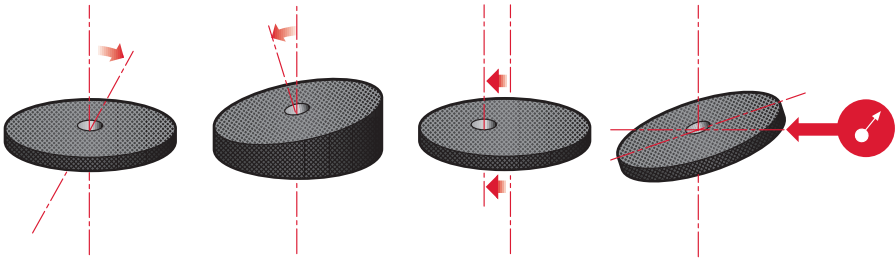

Figure 49

Vibration control

For grinding tool designers and manufacturers, three basic methods of dealing with vibration problems can be identified.

1. *Tackle the source of the vibration:* Reduce the forces generating vibrations (vibration reduction).

The ideal solution is clearly to eliminate or minimize these forces. However, this is quite difficult in practice. Much work also focuses on design, manufacture and quality control by suppliers of abrasives (wheels, etc.).

2. *Isolate the problem:* Insulate the operator from the vibrations generated (vibration damping).

Broadly speaking, this is the most common method for hand-held power tools, though not always the best one.

Vibration damping usually involves inserting a flexible rubber or metal coil as a spring mechanism between the tool itself and the handle (grip). The tool continues to vibrate as nothing is done to reduce vibrations in the tool, but the handle remains relatively still.

3. *Make the tool less sensitive:* Use the tool's mass to counteract vibration-generating forces (vibration damping).

Instead of inserting flexible components between tool and handle to damp vibrations, mass and moment of inertia can be added. Even a modest increase in weight and careful distribution of mass can achieve excellent results.

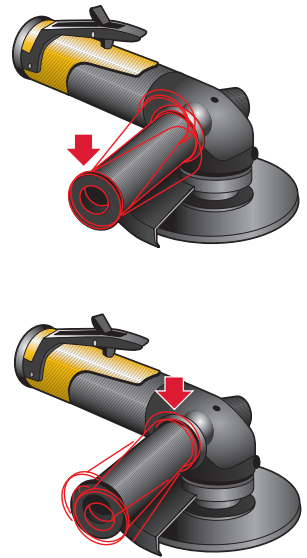

Figure 50. Vibration-damped handle

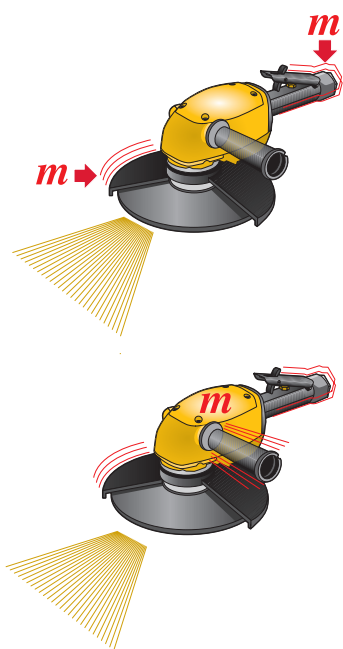

Figure 51

- *A combination of methods*

Innovative design and painstaking R&D have led to effective vibration control in grinders by combining these methods.

A case in point is the self-balancing hub used on geared turbine grinders (Autobalancer). The hub contains ball bearings that adjust position to counter alterations in the imbalance as the wheel becomes worn. The regulating effect of this device keeps vibration levels low throughout the life of the wheel.

What can the user do?

- *Vibration levels*

As stated above, grinding wheels, etc. are definitely the major source of vibration. Care in choosing, fitting and working with wheels will enable operators to reduce vibrations considerably.

Above all, it's important to use quality wheels only, with as little imbalance as possible. The operator can also make sure the wheel is properly centered during fitting⁵.

Imbalance in the wheel can increase during grinding as certain parts on the wheel periphery are worn down more rapidly than others. As soon as the wheel starts to look oval, it should be replaced.

- *Work rotas (task rotation)*

Total daily exposure (or dose) comprises the actual vibration levels and the length of exposure. A work rota to vary the tasks done will cut this exposure time for each operator, and so reduce the overall risk for all operators.

Dust

Inhaling dust can merely be unpleasant and tiresome. It can also lower efficiency by making it harder for us to breathe. Some dust is also toxic or aggressive.

The operator should always be protected from inhaling dust by using a mask. Ventilation and extraction systems are otherwise the most common methods of dealing with dust. For grinders, this mainly means fitting extraction hoods, and spot suction cups and hoses.

It is most effective to extract dust at source – as close to the workpiece and the edge of the abrasive as possible. Good background ventilation with extractor fans is also important.

⁵This can't actually be seen; the operator must test the grinder at free speed with the wheel fitted. If the tool vibrates, the wheel should be turned through 180° so the wheel imbalance shifts in relation to the tool.

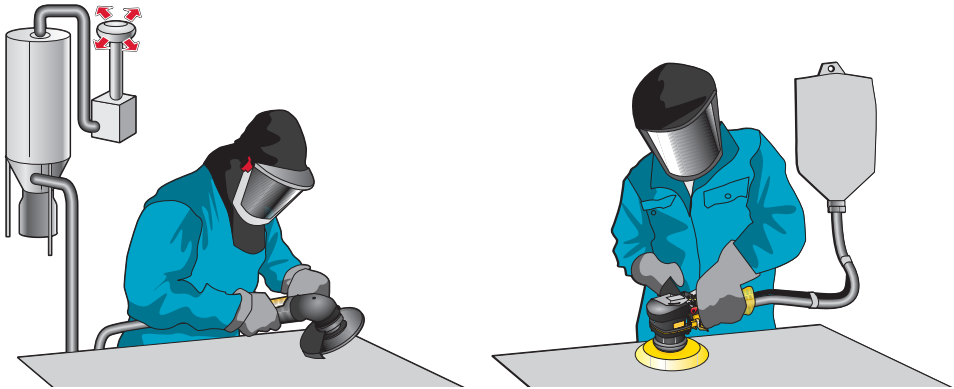

Figure 52. Spot suction

Noise

Noise can damage hearing, and is also a stress factor, disturbing concentration and undermining work performance.

The work process is by far the most serious noise source with grinders, especially rough grinding. Often there's not much that can be done about it. The tool is a separate source of noise in addition to "process sound." A silencer can reduce the total noise volume.

Airflow noise is caused when air is discharged at high speed. Exhaust velocity can be reduced by careful design of outlet ducts. Exhaust silencers are effective in reducing airflow noise by filtering off the high-frequency range. Some grinders also feature a spring-loaded valve for exhaust air, giving virtually the same noise reduction at free speed as at maximum output.

Vibrating parts or surfaces transmit sounds. At high frequencies, this can be a problem. Vibration-control measures will indirectly reduce such noise; for example, suspending the motor between vibration-damping rubber components.

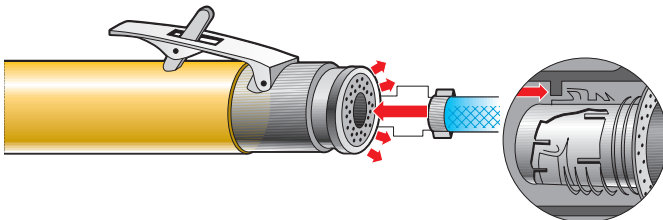

Figure 53

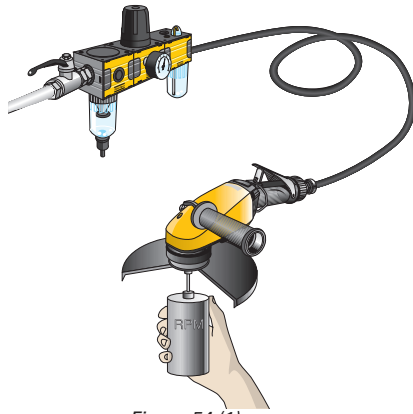

Figure 54 (1)



Figure 55 (2)

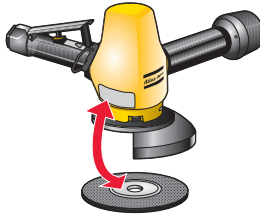

Figure 56 (3)



Figure 57 (4)

Safety

Rules for safer grinding

Grinding is a job that has to be taken seriously. The equipment used must be handled properly and the grinding situation itself treated with respect. The forces involved can be a source of danger if safety aspects are overlooked. The operator should always be extra careful and follow these nine basic rules before starting work:

1. Check the free speed of the tool, so that it cannot rotate faster than the maximum rpm stated on the wheel.
2. Use a wheel guard when grinding with a grinding wheel that's meant to have a guard.
3. Use the right dimension of grinding wheel, so that the grinding wheel's rotational speed (in rpm) is not exceeded.
4. Check that the grinding wheel isn't cracked or otherwise damaged.

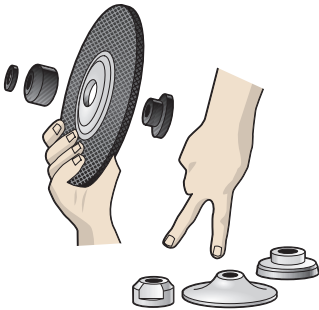

Figure 58 (5)



Figure 59 (6)

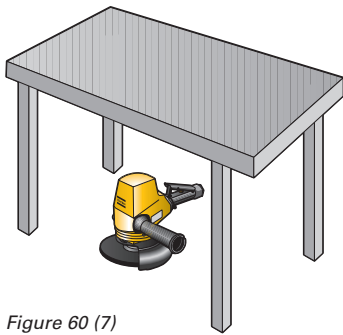

Figure 60 (7)



Figure 61 (8)

5. Check that the right flanges are used, that they're attached properly, and are smooth with no trace of burr or flash.
6. Use the personal protective clothing or other equipment provided (goggles, ear protectors, gloves, helmets, masks, etc.).
7. Test run in a safe enclosed area, e.g., beneath the workbench.
8. Ensure tool maintenance is performed regularly. Preventive maintenance is always a better and safer bet than operating a tool until it fails.
9. Always consult national and international standards and regulations on safety.

ATLAS COPCO GRINDERS AT A GLANCE

Grinders for all applications

Over the years, Atlas Copco has pursued intensive and large-scale R&D projects on many aspects of product design. Today, Atlas Copco is one of the world's foremost suppliers of all handheld power tools, including air-powered quality grinders.

You'll have no trouble finding an Atlas Copco grinder to suit your specific needs. You have some 100 different models to choose from, covering everything from precision deburring to really rough grinding. There's also a large selection of accessories available, making the list of applications virtually endless.

Atlas Copco grinders are powerful in relation to their weight, and easy to handle. They enable you to work more effectively without feeling as tired. Their high quality and operational reliability, combined with sound ergonomic design, ensure excellent productivity.

Ergonomics as a business philosophy

When people suffer, so does productivity. There's definitely a strong trend now towards ergonomics in the workplace and consideration of the environmental implications of work processes.

This is especially gratifying for us after many years' dedicated effort. We feel we've played a major role in advancing the environmental cause by developing efficient, technically advanced and user-friendly hand tools.

Development must continue however. Good power-tool design can alleviate some of the problems still found in today's industries. Improvements here can reduce absenteeism and operator fatigue, boosting productivity and production quality.

Our grinders have been designed with ergonomics in mind to give you every opportunity of boosting productivity. Their high quality and impressive performance are enhanced by even more effective control of vibration, dust and noise than on the conventional tools in our standard assortment.

Selection guide

Applications and Atlas Copco models

Grinding applications	Grinders					
	Die grinders LSF 07/19 28/38	Vertical grinders LSS 53/64/84	Geared turbine grinders GTG 40 GTG 25	Angle grinders LSV 19/28/38	Straight grinders LSR 28/38 43/48/64 GTR 40	Sanders LSO 30-32 LST 20-30
Die grinding with:	11 minutes	13 minutes	15 minutes			
• rotary burr	•					
• mounted point	•					
Rough grinding with:						
• straight-sided wheel					•	
• depressed-center wheel		•	•	•		
• cup wheel		•	•			
• cutting-off wheel		•	•	•		
• mounted point	•					
• cone wheel					•	
Surface grinding with:						
• coated abrasive, dry sanding		•	•	•		•
• coated abrasive, wet sanding				•		
• nylon-coated abrasive	•	•		•		
• lambswool bonnet, etc.				•		
• wire brushes		•	•		•	

Table 7

ATLAS COPCO POCKET GUIDES

Title	Ordering No.
Air line distribution	9833 1266 01
Air motors	9833 9067 01
Drilling with handheld machines	9833 8554 01
Grinding	9833 8641 01
Percussive tools	9833 1003 01
Pulse tools	9833 1225 01
Riveting technique	9833 1124 01
Screwdriving	9833 1007 01
Statistical analysis technique	9833 8637 01
The art of ergonomics	9833 8587 01
Tightening technique	9833 8648 01
Vibrations in grinders	9833 9017 01
Vibration exposure assessment for power tools	9833 1508 01
Cable management	9833 1640 01
Testing and calibration in assembly technology	9833 1720 01
Error proofed production	9833 1437 01
LEAN	9853 8215 01
PowerTool Ergonomics (book)	9833 1162 01

COMMITTED TO SUSTAINABLE PRODUCTIVITY

www.atlascopco.com

