

RTX SERIES HYDRAULIC TORQUE WRENCH

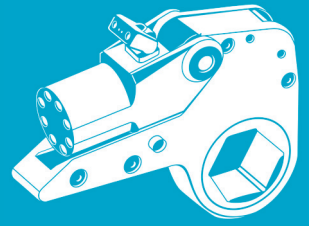

Used worldwide for low clearance applications due to its combination of powerful torque output and low profile.

Atlas Copco



Atlas Copco

RTX-04
S/N000008

CE



RTX SERIES

LOW PROFILE HYDRAULIC TORQUE WRENCH

Our RTX direct-fit, low profile torque wrenches combine high power-to-weight ratio, durability and hands-free operation. The result is a tool that is perfectly suited for low clearance applications that require high torque. Use with the standard set up or customize with high quality accessories.

From design, to manufacturing and calibration, RTX Series is a purpose-built machine. It stands second to none.



AIRCRAFT ALUMINUM ALLOY

Most of the exterior is made up of aircraft-quality aluminum alloy, which provides amazing strength while keeping weight to a minimum.

LARGEST HEX RANGE

Largest range of hex sizes available. Torque output is consistent for any link size. Available in Reduced Radius and 12 point.

HIGH STRENGTH STEEL ALLOY

Heavy duty contact points ensure long tool life.

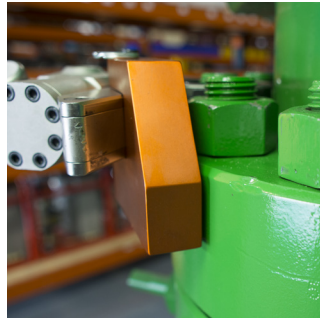

MULTI-AXIS SWIVEL

Greater range of movement on multiple axis allows the hose to move easier compared to one axis swivels.

AUTOMATIC ENGAGEMENT

The powerhead engages the direct fit ratchet link automatically.

CONNECTS WITH JUST ONE PIN

Using just one high strength pin to connect allows operators to quickly change out link sizes.

REACTION OPTIONS AVAILABLE

The in-line reaction pad works beautifully on most applications. For special applications, Atlas Copco offers outside reaction arms and Alco arms to increase reaction points.

RTX SERIES

LOW PROFILE
HYDRAULIC TORQUE WRENCH

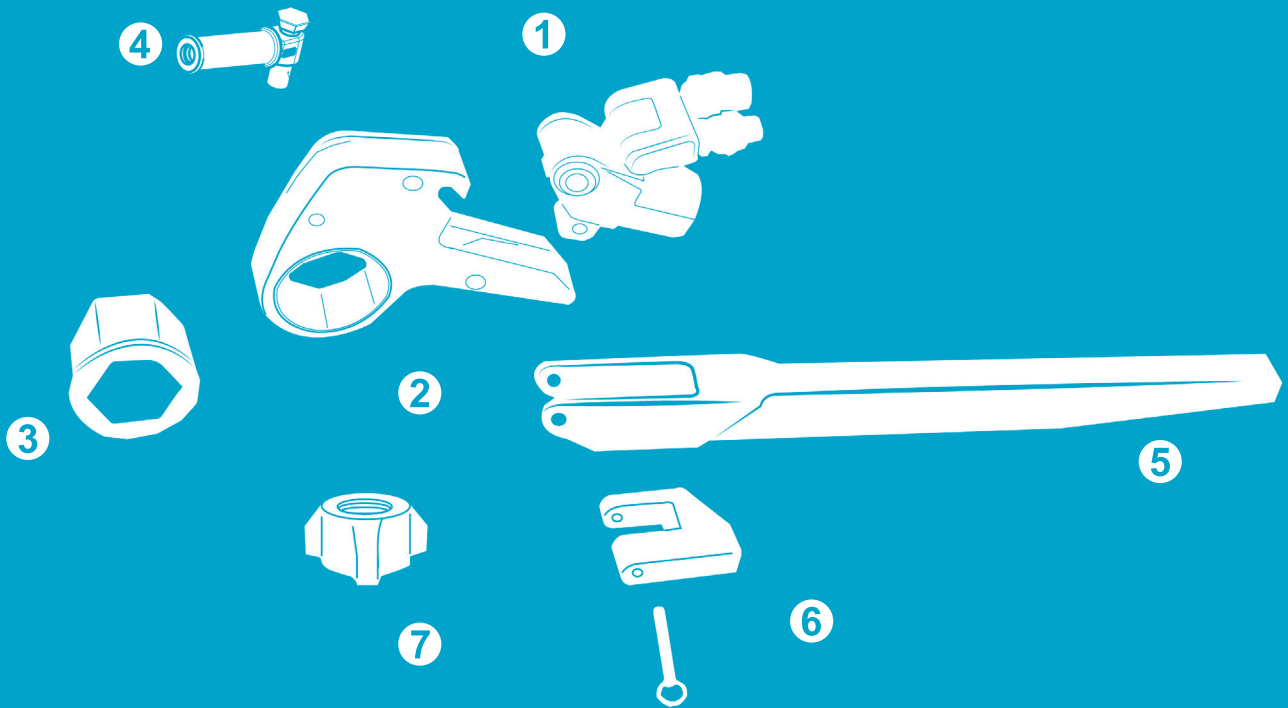

- ① Standard Setup
- ② Standard Link Sizes
- ③ Insert Hex Reducer
- ④ Safety Handle for RTX
- ⑤ Alco Arm
- ⑥ Onside Reaction Arm
- ⑦ Safety Nut

KEY FEATURES

6 Models
torque range
255 ft.lb. to 31,800 ft.lb.
(346 Nm to 43,108 Nm)

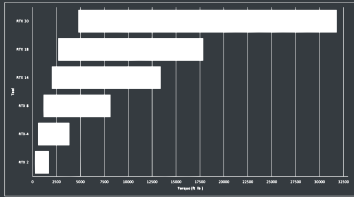

Hex Drive Size

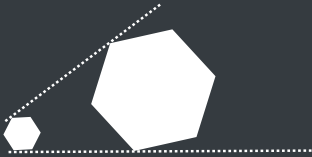

Ranges from 3/4" to 6 1/2"

**+/- 3 %
Accuracy**

STANDARD SETUP

RTX Powerhead
Choose your torque range.

1



Direct Fit Ratchet Links
Choose the Across Flat Hex Link Size* needed for your application. Available in Reduced Radius#.



Dimensions

Model	L		NS (based on ratchet link size)		R		W1		W2	
	in	mm	in	mm	in	mm	in	mm	in	mm
RTX-02	7.2	183	3/4 – 2-9/16	19-65	0.35	9	1.26	32	1.92	49
RTX-04	9.7	248	1-5/16 - 3-1/8	32-80	0.47	12	1.65	42	2.56	65
RTX-08	12.1	308	1-13/16 - 3-7/8	46-100	0.59	15	2.08	53	3.22	82
RTX-14	14.6	372	2 – 4-5/8	50-120	0.72	18.5	2.48	63	3.89	99
RTX-18	15.5	393	3 - 5-1/2	75-140	.87	22.2	2.75	70	4.37	111
RTX-30	18	457	3-9/16- 6-1/8	90-155	1	25.4	3.26	83	5.28	132

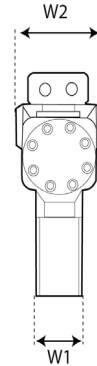
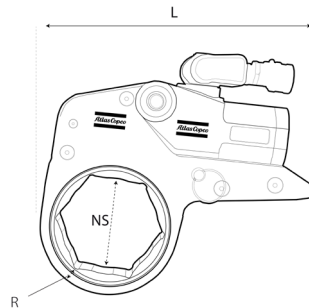

Model	Ratchet Link Hex Size*		Torque Range		Weight		Ordering No.
	in	mm	ft.lb.	Nm	lb	kg	
RTX-02	3/4 – 2-3/4	19-65	255-1710	346-2318	4.5	2	8434 2021 90
RTX-04	1 - 3-1/8	25-85	580-3855	786-5226	9.7	4.4	8434 2021 95
RTX-08	1-5/8 - 4-1/8	46-105	1143-8151	1549-11049	19.5	9	8434 2022 00
RTX-14	2-1/2 – 5-3/8	60-135	2010-13400	2725-18165	33	15	8434 2116 58
RTX-18	3-1/2 - 5-1/2	75-140	2676-17845	3628-24191	51	23	8434 2022 05
RTX-30	3-1/2 - 6-1/2	90-165	4770-31800	6466-43108	78	35.5	8434 2022 10

Designs and specifications are subject to change without notice or obligation. Read all safety instructions in the manual before usage.

*RTX Hydraulic Torque Wrench is uniquely designed to have consistent torque output, regardless of hex size link. That means that you don't have to worry about different torque charts when changing direct hex link size.

#Reduced Radius Ratchets (RR) are .062" (1.57 mm) reduction compared to the standard size links.

ACCESSORIES

2

RATCHET LINKS



Model	Ordering No.
RL02-100	8434 2020 03
RL02-101/27MM	8434 2131 96
RL02-102	8434 2131 99
RL02-103	8434 2132 05
RL02-104	8434 2021 69
RL02-104/32MM	8434 2132 08
RL02-105	8434 2132 14
RL02-107	8434 2021 68
RL02-107 RR	8434 2021 83
RL02-108/38MM	8434 2132 20
RL02-110	8434 2021 07
RL02-110 RR	8434 2021 08
RL02-111/43MM	8434 2132 26
RL02-112	8434 2132 29
RL02-113/46MM	8434 2132 32
RL02-113/46MM RR	8434 2132 35
RL02-114	8434 2020 06
RL02-200	8434 2132 50
RL02-202	8434 2132 56
RL02-203	8434 2132 59
RL02-206	8434 2021 47
RL02-207	8434 2132 68
RL02-208	8434 2132 71
RL02-209/65MM	8434 2021 50
RL02-212	8434 2021 59
RL02-215	8434 2021 77
RL02-24MM	8434 2020 54
RL02-30MM	8434 2132 77
RL02-36MM	8434 2132 80
RL02-41MM	8434 2132 83
RL02-50MM	8434 2021 86
RL02-55MM	8434 2132 86
RL02-60MM	8434 2059 28
RL04-014	8434 2133 19
RL04-100	8434 2133 22
RL04-108/38MM	8434 2133 40
RL04-110	8434 2021 35
RL04-113/46MM	8434 2021 53
RL04-114	8434 2133 43
RL04-200	8434 2133 49
RL04-203	8434 2021 71
RL04-204	8434 2133 58

Model	Ordering No.
RL04-206	8434 2133 64
RL04-208	8434 2133 67
RL04-209/65MM	8434 2133 70
RL04-212	8434 2133 79
RL04-212 RR	8434 2133 82
RL04-213	8434 2133 85
RL04-215	8434 2133 91
RL04-300	8434 2134 00
RL04-302	8434 2134 06
RL04-308	8434 2134 09
RL04-36MM	8434 2134 18
RL04-41MM	8434 2134 21
RL04-50MM	8434 2134 30
RL04-55MM	8434 2134 36
RL04-55MM RR	8434 2134 39
RL04-60MM	8434 2134 45
RL04-70MM	8434 2021 62
RL04-71MM	8434 2021 63
RL04-75MM	8434 2020 21
RL04-85MM	8434 2134 54
RL08-100MM	8434 2020 24
RL08-105MM	8434 2134 96
RL08-113/46MM	8434 2020 66
RL08-200	8434 2020 68
RL08-203	8434 2020 69
RL08-204	8434 2135 20
RL08-206	8434 2020 70
RL08-208	8434 2135 26
RL08-209/65MM	8434 2116 04
RL08-212	8434 2021 44
RL08-215	8434 2020 71
RL08-302	8434 2020 72
RL08-305 3 5/16IN	8434 2020 77
RL08-308	8434 2020 74
RL08-312/95MM	8434 2135 41
RL08-314	8434 2021 65
RL08-404	8434 2020 78
RL08-50MM	8434 2135 47
RL08-70MM	8434 2135 59
RL08-75MM	8434 2135 65
RL08-80MM	8434 2135 74
RL08-85MM	8434 2021 11
RL08-90MM	8434 2020 81
RL14-115MM	8434 2136 04
RL14-130MM	8434 2136 10
RL14-206	8434 2136 13

Model	Ordering No.
RL14-209/65MM	8434 2020 39
RL14-302	8434 2136 31
RL14-308	8434 2136 34
RL14-312/95MM	8434 2020 42
RL14-314	8434 2020 45
RL14-402	8434 2136 46
RL14-404	8434 2020 84
RL14-410	8434 2136 55
RL14-506	8434 2136 58
RL14-80MM	8434 2021 20
RL14-85MM	8434 2021 32
RL18-115MM	8434 2136 97
RL18-212 2 3/4IN	8434 2059 47
RL18-302	8434 2137 08
RL18-308	8434 2020 87
RL18-312	8434 2020 90
RL18-314	8434 2137 15
RL18-404	8434 2020 48
RL18-410	8434 2020 93
RL18-500	8434 2021 56
RL18-506	8434 2021 23
RL18-80MM	8434 2137 18
RL30-100MM	8434 2137 33
RL30-115MM	8434 2137 42
RL30-120MM	8434 2137 45
RL30-130MM	8434 2020 53
RL30-150MM	8434 2137 60
RL30-170MM	8434 2137 69
RL30-302	8434 2137 75
RL30-314	8434 2137 87
RL30-404	8434 2137 90
RL30-410	8434 2021 00
RL30-500	8434 2020 99
RL30-506	8434 2020 51
RL30-512	8434 2137 93

*Other size ratchet links also available. Please contact your local Atlas Copco representative to get a complete list of sizes. We can also build custom links upon request.

3 INSERT HEX REDUCER

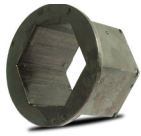

Starting Size	Reduces to	Ordering No.
2 3/4	1 5/8	4222 2134 17
2 3/4	1 13/16	4222 2134 20
2 3/4	1 7/8	4222 2134 23
46mm	36mm	4222 2134 26
50mm	41mm	4222 2134 29
50mm	46mm	4222 2134 32
1 13/16	30mm	4222 2119 58
1 13/16	36mm	4222 2119 62
1 13/16	42mm	4222 2119 66
2	1 3/4	4222 2137 74
2	1 13/16	4222 2137 77
2 1/4	1 5/16	4222 2137 80
2 1/4	1 1/2	4222 2137 83
2 1/4	1 7/8	4222 2137 86
2 1/2	1 7/8	4222 2119 70
2 3/4	2 1/2	4222 2137 89
2 3/4	2 1/16	4222 2137 92
2 3/4	2 1/8	4222 2137 95
2 3/4	2 3/16	4222 2137 98
2 3/4	2 1/4	4222 2138 01
2 3/4	2 3/8	4222 2138 04

Starting Size	Reduces to	Ordering No.
2 15/16	2 9/16	4222 2138 07
3 1/8	1	4222 2138 10
3 1/8	1 1/2	4222 2138 13
3 1/8	1 5/8	4222 2138 16
3 1/8	1 3/4	4222 2138 19
3 1/8	2	4222 2138 22
3 1/8	2 3/8	4222 2138 25
50mm	19mm	4222 2138 28
50mm	32mm	4222 2138 31
50mm	41mm	4222 2138 34
50mm	42mm	4222 2138 37
50mm	46mm	4222 2138 40
55mm	50mm	4222 2138 43
65mm	55mm	4222 2119 74
70mm	60mm	4222 2119 78
70mm	65mm	4222 2119 82
100mm	80mm	4222 2140 62
2 3/16	2	4222 2140 65
3 1/8	2 15/16	4222 2140 68
3 1/8	50mm	4222 2140 71
3 1/8	55mm	4222 2140 74
3 1/8	60mm	4222 2140 77
3 7/8	3 1/2	4222 2140 80
60mm	50mm	4222 2122 07
60mm	55mm	4222 2122 11
70mm	46mm	4222 2140 83

4 SAFETY HANDLE



Model	Ordering No.
Handle kit RL-02	8434 2170 35
Handle kit RL-04	8434 2170 36
Handle kit RL-08	8434 2170 37
Handle kit RL-14	8434 2170 38
Handle kit RL-18	8434 2170 39
Handle kit RL-30	8434 2170 40

5 ALCO ARM



Model	Ordering No.
RTX02-ALC	8434 2057 58
RTX04-ALC	8434 2057 60
RTX08-ALC	8434 2057 62
RTX14-ALC	8434 2057 64
RTX18-ALC	8434 2057 66
RTX30-ALC	8434 2057 67

6 ONSIDE REACTION ARM



Model	Ordering No.
RTX02-14	4222 2107 14
RTX04-14	4222 2109 27
RTX08-14	4222 2110 44
RTX14-14	4222 2141 22
RTX18-14	4222 2141 23
RTX30-14	4222 2144 43

7 SAFETY NUT

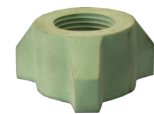

Stud Size	Ordering No.
2"	8434 2129 19
2-1/2"	8434 2129 18
2-1/4"	8434 2129 16
1-7/8"	8434 2129 15
3"	8434 2129 13
2-3/4"	8434 2129 12
1-3/4"	8434 2129 10
1-5/8"	8434 2129 09
1-1/2"	8434 2129 07
1-3/8"	8434 2129 06
1-1/4"	8434 2129 04
1-1/8"	8434 2129 03
1"	8434 2129 01
7/8"	8434 2129 00



COMMITTED TO SUSTAINABLE PRODUCTIVITY

We stand by our responsibilities towards our customers, towards the environment and the people around us. We make performance stand the test of time. This is what we call - Sustainable Productivity.

www.atlascopco.com

Atlas Copco