

The Atlas Copco logo is positioned in the top right corner, featuring the company name in a white serif font between two horizontal white bars, all set against a teal background.The background is a composite image of a city skyline at night, overlaid with a glowing white network of lines and nodes. Various circular icons are scattered throughout, including a fan, a wheel, a car, a battery, and a robotic arm. A large blue triangle in the bottom left corner contains a technical drawing of a vacuum pump.

Vacuum Solutions- An overview

Industrial Vacuum Pumps and Systems

Industry leading vacuum pumps and central systems



Vacuum, the invisible force, is indispensable in industrial production facilities around the world.

When an industrial application requires a clean environment or pressure below atmospheric levels, a steady supply of vacuum is needed.

From food packaging, electronics, glass bottle and can production, paper printing, toothpaste degassing, automotive parts handling, pharmaceuticals conveying, plastic extrusion, woodworking, brick and clay manufacture, to almost all general manufacturing, utility vacuum is everywhere.

At Atlas Copco, our business is propelled by the drive to make processes run more effectively by understanding the needs of the industries we serve. Whatever the application, we provide the vacuum solution.

As the leading innovator in the industrial vacuum market, we have continued focus on energy efficiency that translates into savings for our customers. Our products are the starting point to providing a total vacuum solution for dedicated point-of-use machines and central vacuum systems.

An Atlas Copco vacuum solution for every application



Degassing



Consumer electronics



Pneumatic conveying

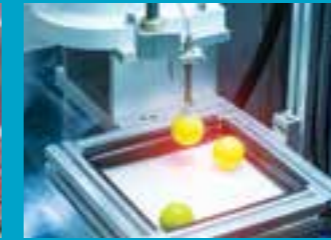

Holding/Lifting/Moving



Woodworking



Preserving



Drying



Altitude simulation



Food processing



Medical applications



Extrusion



Cooling



Glass



Pressing/Laminating



Filtration



Shaping/Forming



Canning



Packaging

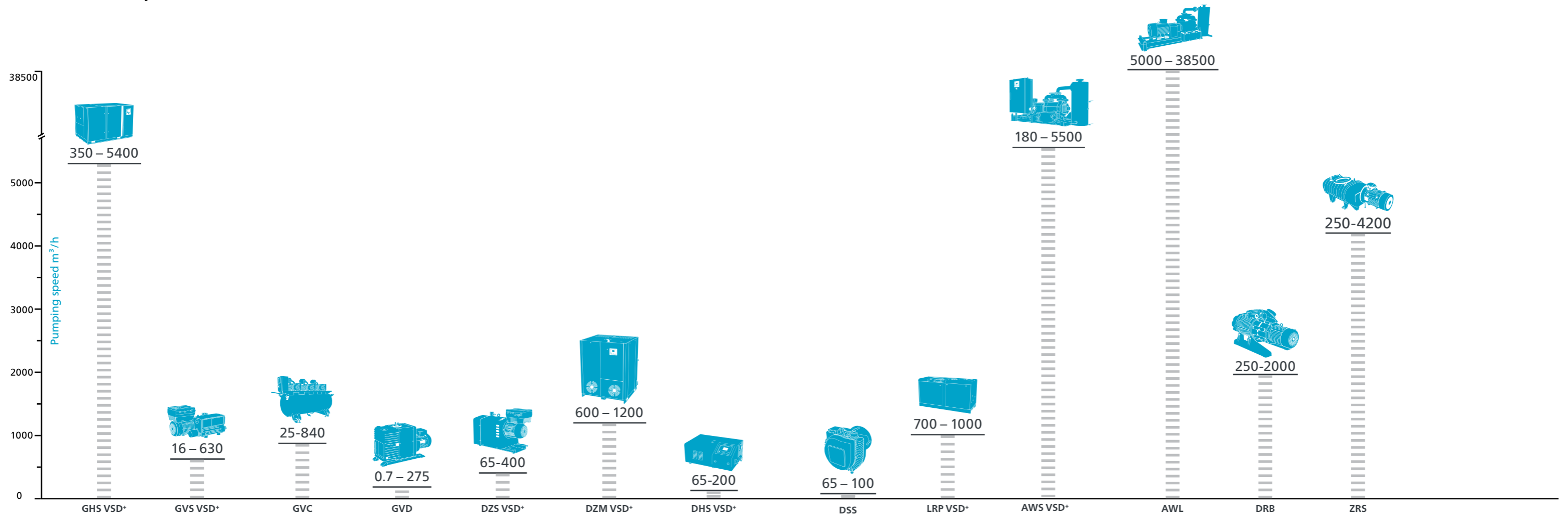

▶ Centralized machines

The future state: A centralized network supplying the fourth utility, vacuum. Multiple vacuum loads are balanced into a stable demand monitored and served by Atlas Copco VSD+ vacuum equipment co-located in a utility room.

Well-designed central vacuum systems can reduce operating costs, increase productivity while dramatically improving the working environment in the process room.

Drivers for centralization



Capital cost



Flexibility



Heat

Energy efficiency

Maintenance

Noise

Maintenance

Reliability

Air quality



Oil-sealed Rotary Screw vacuum pumps



GHS 350-1900 VSD+
GHS 3800-5400 VSD+

Ultimate pressure: 0.35 mbar(a)

The GHS VSD+ series is a range of new-generation, intelligent, oil-sealed rotary screw vacuum pumps with Variable Speed Drive (VSD) technology from Atlas Copco. Based on the well-known and durable plug-and-play design principles of Atlas Copco compressors, these vacuum pumps have been designed by vacuum engineers to deliver peak performance at your operating pressure. The GHS 350-5374 VSD+ series are suitable for plastics, glass, bottling, canning, wood, packaging, printing and paper and meat packaging industries.



Packaging



Glass



Canning



Consumer electronics

Features you can rely on:

Pumping speed: 350-5374 m³/h

- Superior performance against benchmarked oil-sealed and dry vane vacuum pump technologies
- Increased efficiency – State-of-the-art screw technology, Variable Speed Drive (VSD) and innovative motor design combine to produce a leap forward in efficiency
- State-of-the-art monitoring system for your vacuum pumps with Elektronikon®
- Quiet operation – Noise levels are around half that of comparable technologies
- Reduced environmental impact due to ultra-high oil retention at all operating pressures
- Up to 50% in energy savings
- Technology factor – The efficient Atlas Copco screw
- Set point control – Optimizing the machine output to the real process demand
- VSD – Matching variable performance with variations in load
- Reduction of startup power through intelligent inlet valve control

With Atlas Copco's integrated energy recovery system, it is feasible to recover up to 75% of electrical energy input as hot water.



Intelligent Liquid Ring vacuum pumps



LRP VSD+

Pumping speed: 700-1000 m³/h
Ultimate pressure: 25 mbar(a)

The new LRP VSD+ brings the liquid ring principle into the 21st century. Space saving, the LRP VSD+ series has one of the smallest footprints in the market. Available as a compact standard package, everything you need, including the accessories and main motor is delivered in a single, neat enclosure.

Based on the proven Hick Hargreaves design and with over 150 years of vacuum tradition, the pump offers optimized performance with an improved impeller design. The stainless steel impeller is highly resistant to corrosion.

Two Variable Speed Drives (VSD) – one of which is for vacuum set point control helps maintain and match required vacuum levels. The second VSD helps control and optimize the water flow. The integrated operation of both the VSD's makes this the most energy efficient vacuum pump for wet and humid applications.



Tire manufacture



Expanded Polystyrene production



Chicken evisceration



Milk powder drying

The intelligent HMI constantly monitors the condition of the pumping chamber, and translates that to precisely control the element rotation speed and the cooling water entering the vacuum pump. This provides the highest performance and lowest running costs for wet applications or high vapor loads.

Features you can rely on:

- Compact standard package design with single point monitoring
- A true plug-and-play pump
- Inlet-Outlet (DN 100) and mains cable entry at the top
- IP54 rated dust and water resistant cubicle
- Wet/dry canopy, separating the electronics from the process
- Anti-seizure algorithm for periods of inactivity

- Unique cavitation protection algorithm ensures reliable vacuum and extended durability
- Total recovery mode and automatic water top-up for improved performance and energy savings
- Smart monitoring and remote controllability through Elektronikon® and ES connectivity

The LRP VSD+ is a first of its kind machine with variable performance and boosted vapor handling through twin synchronized VSD and internal cooling spray nozzles.

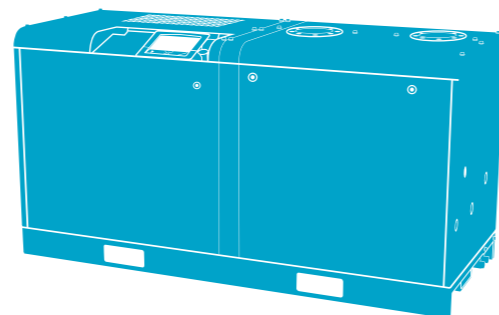

Intelligent Multi-Claw vacuum pumps



DZM VSD+

Pumping speed: 600-1200 m³/h
Ultimate pressure: 150 mbar(a)

The DZM VSD+ series is a complete multi-claw vacuum pumping system in a box.

A solution perfectly designed to meet larger process demands with a central vacuum system. This vacuum pumping package offers a completely controllable system ranging from 44 to 1,230 m³/h integrated into one cabinet with a simple plug-and-play concept.



Woodworking



Product handling



Food processing



Filtration

Features you can rely on:

- Controlled by a single intuitive HMI, the DZM VSD+ is the perfect centralized high capacity dry vacuum pump
- Built-in corrosion resistance (standard) with corrosion-resistant stainless steel claws
- Easily accessible pumping chamber for cleaning without accessing the gearbox and disturbing the timing
- Modular design allows flexibility and efficiency in terms of maintenance and life cycle costs
- Multi-vacuum pump controllers allow for start/stop and control of multiple vacuum pumps simultaneously, according to set working pressures

The silent DZM canopy houses a stack of reliable claw elements to increase pumping capacity while maintaining a process set pump with clean, dry variable vacuum performance.

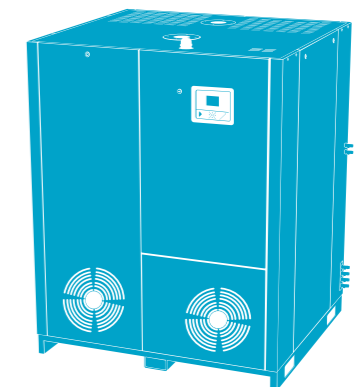

Dedicated machines

Today's industry relies on dedicated vacuum machines serving processes at the point of use. Sometimes the scale of operation, or the particulars of the application mean that centralization isn't a pragmatic approach, but that doesn't mean we can't dramatically improve the process through improved vacuum supply.

At Atlas Copco we believe there is always a better way, so we looked at the most common dedicated vacuum technologies available in the market and improved on the state-of-the-art: resulting in a range of machinery featuring best-in-class performance, deep-end pressures, supreme efficiency and bullet-proof reliability.

Going one step further, the addition of frequency controlled motors or ELEC CAB control panel converts a traditional fixed speed design into a variable speed set-point controlled pump for stable vacuum over a wider operation range and enhanced efficiency.

The result is a distributed network of smart machines, ready for industry 4.0.



Dry Screw vacuum pump

DHS VSD+

Pumping speed: 65-200 m³/h
Ultimate pressure: 0.01 mbar(a)

The DHS 65-200 VSD+ is clean, clever and compact. With zero oil needed, it is free of any oil emissions and has zero contamination, so you can expect an exhaust that is extremely clean. You can also expect superior performance with excellent vapor and dust handling capabilities. The simple yet effective design and internal parts reduce maintenance and system downtimes.

Housed in a noise reducing canopy, you get a noticeably quiet, vibration-free operation with a low pitch sound level. Its compact footprint ensures a quick and trouble-free installation.



Component drying



Vacuum packaging



Composites molding



Laboratories

The new screw profile of the DHS 65-200 VSD+ offers best-in-class performance in its category. Equipped and controlled with the MKV Elektronikon®, the pump offers unrivalled built-in intelligence.

Features you can rely on:

- The innovative bearing vent prevents contamination of the grease-lubricated bearings by the inlet gases from the process
- The compact design reduces noise levels and retains the integrity of the parts within the pump
- With Elektronikon® you get the latest status updates on running and stopped hours, programmable timers, warning, faults and shutdown indications, etc.
- The belt transmission operates on a soft start which produces less stress on the belt and increases its lifetime

The first vacuum pump in the world to be certified as "class 0", this pump is clean, clever and compact.

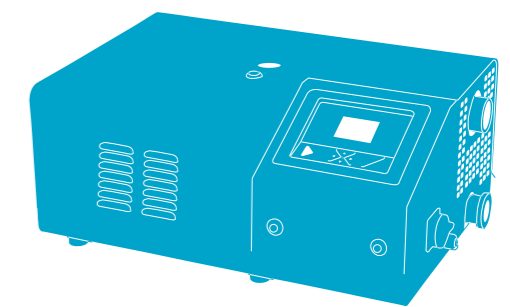

Dry Claw vacuum pumps



DZS VSD+

Pumping speed: 65 - 300 m³/h
 Ultimate pressure: 50 mbar(a) - 140 mbar(a)

The robustness, efficiency and contaminant handling capability of the DZS vacuum pumps make them the smart choice for your application. Built to your exact standards and quality, these dry claw pumps provide you with a trouble-free and cost-effective solution.

Hygienic wash down version is available for food applications and ATEX dust version for pneumatic conveying.



Pneumatic Conveying



Printing



Plastic Extrusion



Paper Converting

Features you can rely on:

- Class 0 certified dry claw vacuum pumps; single stage, oil-free, air-cooled and VSD+ inverter drive technology built-in
- Efficient motor with variable speed option for complete controllability
- Built-in corrosion resistance (standard) with corrosion resistant stainless steel claws
- Easily accessible pumping chamber for cleaning without accessing the gearbox and disturbing the timing
- Modular design allows flexibility and efficiency in terms of maintenance and life cycle costs
- Equipped with an inverter drive on the motor, enabling PI-Loop functionality as well as multiple options for remote connectivity including the in-house developed Atlas Copco VSD+ App

The DZS VSD+ has a unique design with stainless steel claws, easy access pumping chamber and patented forced cooling flow, meaning it can withstand the toughest of applications and run constantly at 50 mbar ultimate pressure.

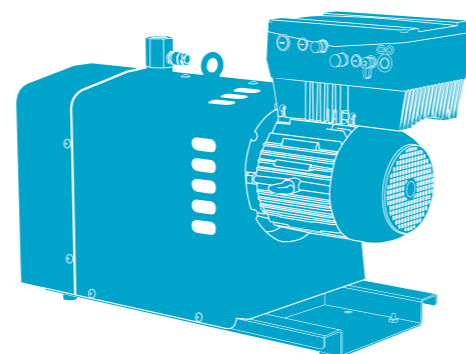

Liquid Ring vacuum pumps



AWS VSD+

Pumping speed: 200-37500 m³/h
 Ultimate pressure: 30 mbar(a)

Atlas Copco's AWS, AWD and AWL series of liquid ring vacuum pumps. They are offered as standard packages in a number of configurations for operations in once-through, partial or total recirculation mode.

Stainless steel wetted parts are standard for partial or total recirculation systems. The AW liquid ring vacuum pumps are available for both single (AWS) and two stage pumps (AWD) with capacities from 200-37500 m³/h and vacuum levels down to 30 mbar(a).

For more complex process system requirements, we offer custom engineered packages.



Minerals Filtration



Rubber vulcanization



Drying



Sugar processing

Features you can rely on:

- Modular design of three package types: once through, partial recirculation and total recirculation
- Optional materials of construction: Cast iron, stainless steel fitted, stainless steel complete
- Accessories have stainless steel wetted parts as standard
- Non-hazardous area versions and full range of skid mounted accessories available

When a rock solid pump is teamed up with the latest in control technique, the result is a beautiful combination of brains and brawn. VSD+ option is available up to 1600 m³/h.

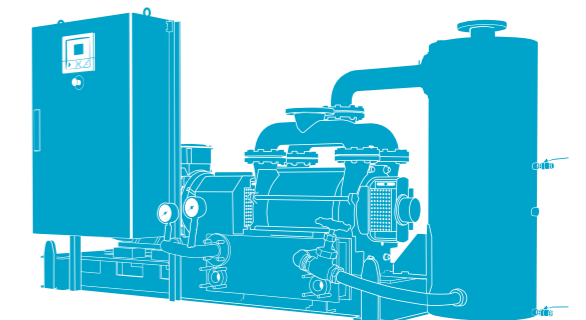

Oil-sealed Rotary Vane vacuum pumps



GVS VSD+

Pumping speed: 16-700 m³/h
Ultimate pressure: 0.5 mbar(a)

The GVS VSD+ series are a robust and highly regarded series of vacuum pumps with a technologically advanced market leading design. The GVS VSD+ operates according to the proven oil-sealed rotary vane principle that has been successfully used for many years in all general vacuum applications of industry.

Providing highly efficient vacuum pumping performance, the GVS VSD+ series is ideal for critical applications in packaging, woodworking, rubber, plastics, electronics, paper and printing, material handling, and other exacting industries.

Our tank-mounted systems with single-stage, oil-sealed rotary vanes provide a dependable solution for numerous vacuum demands.



Food packaging



Lamination



Vacuum bagging



Medical systems

They are supplied ready-to-use with a tank, an electrical cabinet with controller and a filter in front of each pump.

Features you can rely on:

- Packed with innovative features that ensure the highest possible performance at the lowest possible lifecycle cost
- Built-in gas ballast fitted as standard to assist in water handling capability
- Suitable for continuous operation between 400 mbar(a) and ultimate pressure
- A complete, ready-to-use package with all the options and accessories required for general rough vacuum applications

With 10 models available, we have the right pump for you, and now available as local VSD+ variant, featuring localized variable performance for stable pressure, improved productivity and reduced energy requirement.

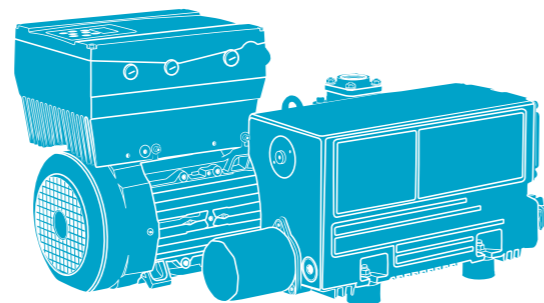

Scroll pumps



DSS

Pumping speed: 65-100 m³/h
Ultimate pressure: 0.3 mbar(a)

The DSS scroll vacuum pump is the latest addition to Atlas Copco's industrial dry pump range. With only one moving part and no contacting design, the all-aluminium construction guarantees silent, dry, high efficiency and low maintenance vacuum generation across the rough vacuum spectrum. Unique gas porting and gas ballast features provide for excellent vapor handling capabilities.



Packaging

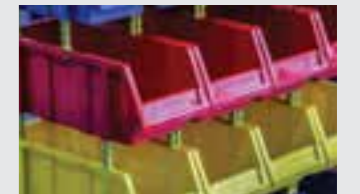

Forming



Drying



Laboratory vacuum

Features you can rely on:

- Simple, clean and modern design that is compact and rugged
- Removable front cover for access to scroll and inlet filter
- Inlet non-return valve
- Complete controllability with the ability to be inverter driven
- Up to 50% lower power consumption compared to vane pumps

Simple and elegant, this silent pump is as comfortable in the office as it is in the workshop, dry and durable machine for stable vacuum at low to medium flow rates.

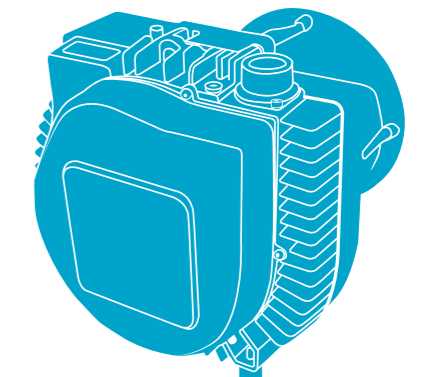

Mechanical Booster pumps



DRB 250-2000
ZRS 250-4200

Based on the simple Roots principle, our mechanical booster pumps remain the favorite pumps for applications where high pumping speeds are required for pressures in the region of 0.01 to 50 mbar. This pump must always be backed by another pump, which can deliver against a high-pressure differential to atmospheric pressure. Operating at relatively low pressures, the mechanical booster pump is not exposed to the same concentrations of corrosive process media as is the backing pump, which makes it highly reliable.



High-speed packaging



Drying & Freeze drying



Vacuum cooling



Industrial vacuum

Features you can rely on:

Pumping speed DRB: 250-2000 mbar(a)
Ultimate pressure: 0.01 mbara

DRB 250-2000

- Available with multiple motor drives and use air-cooled, flange-mounted, standard three-phase motor
- Can be used either vertically or horizontally with the option to change the position when required
- Complies with the premium energy efficiency class IE3. This means lower power consumption and carbon emissions

DRB Series



ZRS Series



Pumping speed ZRS: 375-4985 m³/h

ZRS 250-4200

- Suitable for applications where high pumping speeds are required in the pressure region of 0.01 to 50 mbar/0.0075 to 37.5 Torr
- The ZRS pumps have a high quality, oil-free pumping mechanism
- The design of the shaft seals is optimized to ensure that no lubricants can migrate into the pumping mechanism
- The dynamically balanced rotors and precision ground gears contribute to the smooth, quiet operation of the pumps

The DRB Roots booster pump is air-cooled and with integrated bypass and offers peace of mind in food packaging applications.

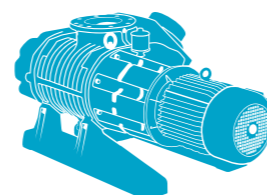

Controllers



Atlas Copco's Elec Cab and ES central controllers are designed to convert standalone fixed speed machines into intelligent vacuum systems.

ES Central Controllers

The ES Central Controller creates an interconnected system out of multiple VSD+ machines. Allowing for automatic balancing of running hours & synchronized performance between different machines, maximum energy efficiency, servicing costs and maintenance scheduling. The ES solution is available in a wall mounted electrical cabinet as shown in the picture below, or as an integrated software option on any Atlas Copco vacuum pump with a built-in Mk.5 Elektronikon®, such as the LRP VSD+ or the GHS VSD+.



ELEC CAB pump controllers

The Elec Cab controls Atlas Copco naked pumps as well as competitor pumps, regardless of their element technology.

Oil injected vane, screw, scroll, claw, liquid ring or others: the Elec Cab handles all with ease.

By allowing synchronization between the process and the vacuum system, remote monitoring and active process control settings, the Elec Cab centralizes decentralized systems and take your production process to a higher, more cost effective and more reliable level.

Tangible cost savings are brought into the workshop through embedded set point control, VSD-technology and equal wear software.

Now available for 1 to 4 pumps, ranging from 2.2kW to 45kW, in 380-460V.



Accessories

Next to offering market leading vacuum pumps, Atlas Copco is dedicated to delivering a complete solution for your specific vacuum needs.

Therefore a wide range of accessories is available, from prefiltration on inlet side to process piping and outlet filtration.

Please consult your Atlas Copco sales contact for more information tailored to your process' precise requirements.



We know vacuum



Atlas Copco knows the ins and outs of vacuum. As a market leader and innovator in all areas of compression technology, we have developed state-of-the-art vacuum pumps, systems and accessories.

Our customer centers all over the world can deliver the high quality vacuum solutions that suit your application. But these are only part of the services we offer. To keep the vacuum pump highly reliable and efficient throughout its lifetime, service support is available in your location, tailored to your specific needs and delivered by our factory-trained experts.

Making the most of your vacuum system requires care. Professional care, from Atlas Copco.

Knockout pots • Filtration • Liquid Separators Vacuum Receivers • Valves • Vessels

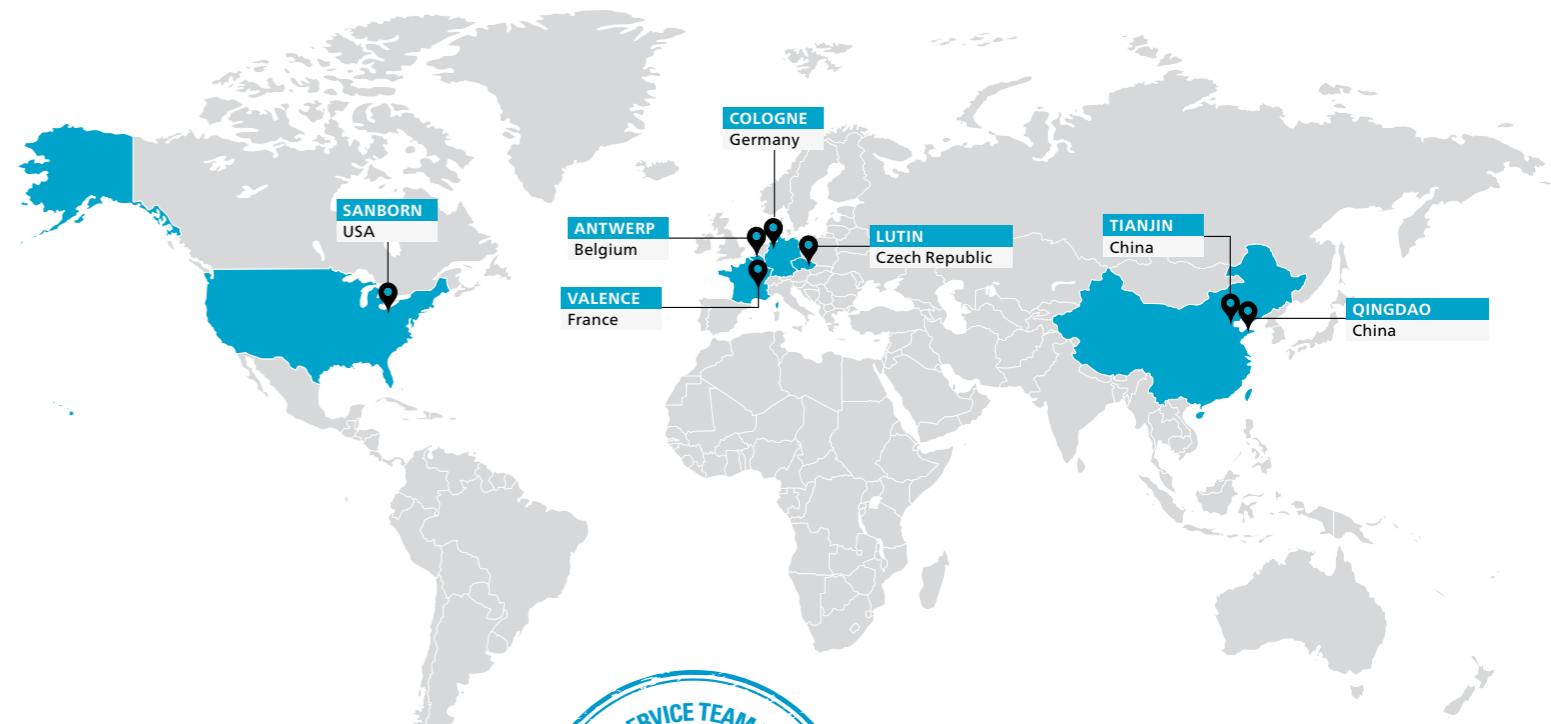

Global production facilities



Notes: _____

Lined writing area for notes.

Notes: _____

Lined writing area for notes.



Atlas Copco Industrial Vacuum
atlascopco.com

