

CP42 Series

Rivet hammers and squeezers



*The aerospace riveting solution
from Chicago Pneumatic*

People.
Passion.
Performance.



**Chicago
Pneumatic**



AEROSPACE MAINTENANCE



Chicago Pneumatic: your global partner for your aerospace maintenance needs

At Chicago Pneumatic, our goal is to deliver best-in-class global service and local support to industrial customers through a dedicated product portfolio and a strong network of authorized distributors. Reliable performance and safety are key drivers for all our industrial products development.

As a complement to our existing product range for aerospace MRO applications, we are introducing a range of tools dedicated to riveting, becoming your global partner for your metal structure repair operations. For your demanding applications, we make sure you get the high-quality products Chicago Pneumatic is known for, for over 115 years.

For all your maintenance and repair needs, you will be able to find the rivet squeezer or rivet hammer you need to complete your task according to regulations in place. We also offer drills, sanders and all riveting accessories (bucking bars, rivet sets, etc...) to carry out your air frame maintenance jobs from A to Z, keeping productivity top-of-mind, no matter how tough the conditions. Our product range is easy to use, ergonomic and allows to work in silence, without vibrations.

DESIGNED FOR AIR FRAME MAINTENANCE APPLICATIONS

Our range fits all frequently used rivets in metal structure repair for aerospace



Rivet Hammers

Productive and easy to use

- **Easy to use**
- **Very good durability**
- **Use together with the Chicago Pneumatic bucking bar for good ergonomics**



7 MODELS TO COVER ALL FREQUENTLY USED RIVETS IN METAL STRUCTURE REPAIR FOR AEROSPACE

Rivet Size (Aluminium)	Model	Part #	Rivet Hammer Type	Stroke
3/32" – 1/8"	CP4281	6151740590	1X	1-1/8" 35 mm
3/32" – 1/8"	CP4282	6151740600	2X	2-1/4" 57 mm
5/32" – 3/16"	CP4283	6151740610	3X	3" 73 mm
3/16" – 7/32" – 1/4"	CP4284	6151740620	4X	3" 78 mm
3/16" – 7/32" – 1/4"	CP4285	6151740630	5X	2-3/8" 68 mm
1/4" – 9/32" – 5/16"	CP4287	6151740640	7X	4" 98 mm
5/16" – 11/32" – 3/8"	CP4289	6151740650	9X	5" 132 mm



Listed specifications are for reference only. Please check tool documentation.

Accessories rivet hammers

Bucking bars

We recommend to use a rivet hammer with a bucking bar equipped with a compression cylinder to decrease reaction in operator's hand.



Part #	Description
6153609420	Bucking Bar Short
6153609430	Bucking Bar Long

Chisels

Use the rivet hammers with Chicago Pneumatic chisel kit (non included accessory)



Part #	Corresponding tool
6153609390	CP4281
6153609400	CP4282 CP4283 CP4284
6153609410	CP4285 CP4287 CP4289



Squeezers Series

Productive and ergonomic

- Practically without vibrations (<math><2,5 \text{ m/s}^2</math>)
- Very silent (as low as 72 dB)
- For rivets up to 3/16"



6 MODELS AVAILABLE, 3 TYPES OF JAWS

- Alligator Short
- Alligator Long
- C Short

Rivet Size (Aluminium)	Model	Part #	Jaw Type
1/16" – 3/32" – 1/8"	CP4210CS	6151710180	C Short
1/16" – 3/32" – 1/8"	CP4210AS	6151710200	Alligator Short
1/16" – 3/32"	CP4210AL	6151710220	Alligator Long
3/32" – 1/8"	CP4220AL	6151710230	Alligator Long
5/32" – 3/16"	CP4220AS	6151710210	Alligator Short
5/32" – 3/16"	CP4220CS	6151710190	C Short



CP4210AS



CP4220AS



CP4210AL



CP4220AL



CP4210CS



CP4220CS

Listed specifications are for reference only. Please check tool documentation.

How to choose the right squeezer and rivet set?

Jaws

B	Upper offset
C	Anvil work clearance
D	Lower offset
G	Total yoke gap
H	Closed height
R	Reach
T	Travel
X	Extreme open position
Y	Extreme closed position

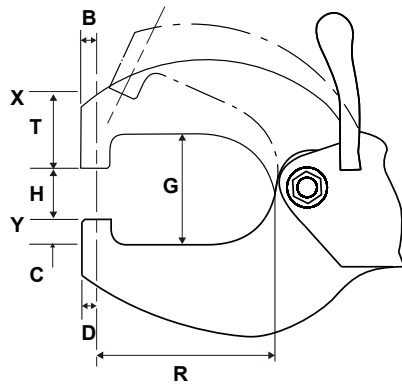

A	Throat gap
B	Upper offset
C	Anvil work clearance
D	Lower offset
G	Total yoke gap
H	Closed height
R	Reach
T	Travel
X	Extreme open position
Y	Extreme closed position

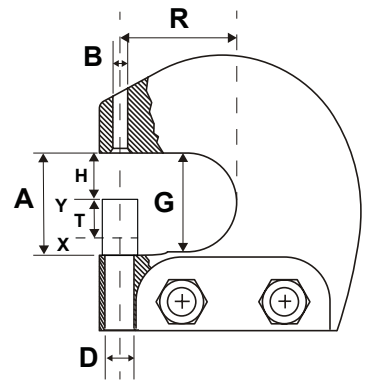

Alligator jaw model	D		G		H		R		T	
	inch	mm	inch	mm	inch	mm	inch	mm	inch	mm
CP4210AS	1/4"	6	1-5/8"	40	5/6"	21	1-1/2"	38	5/8"	16
CP4220AS	1/4"	6	1-5/8"	40	5/6"	21	1-1/2"	38	5/8"	16
CP4210AL	1/4"	6	1-3/4"	44	11/16"	17,5	3"	76	3/4"	19
CP4220AL	1/4"	6	1-3/4"	44	11/16"	17,5	3"	76	3/4"	19

C Jaw model	D		G		H		R		T	
	inch	mm	inch	mm	inch	mm	inch	mm	inch	mm
CP4210CS	1/3"	8	1-1/4"	32	3/4"	18	1-1/2"	38	5/9"	14
CP4220CS	1/3"	8	1-1/4"	32	3/4"	18	1-1/2"	38	5/9"	14

Rivet set choice

How to calculate the correct length of the rivet sets:w

CUPPED RIVET SET

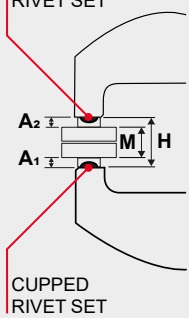

When two cupped rivet sets are used:

The length of the body dimensions of the rivet sets (A1, A2) should equal the closed height dimension of the yoke H minus the total thickness of material being riveted together.

$$A1 + A2 = H - M$$

CUPPED RIVET SET

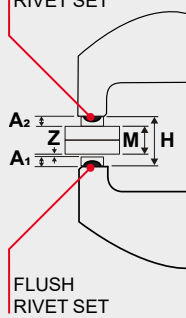

When one cupped set and one flush set are used:

The length of the body dimensions of the rivet sets (A1, A2) should equal the closed height dimension of the yoke H minus the total thickness of material being riveted (M) and the height of the finished rivet head (Z) compressed by the flush set (A).

$$A1 + A2 = H - M - Z$$

FLUSH RIVET SET

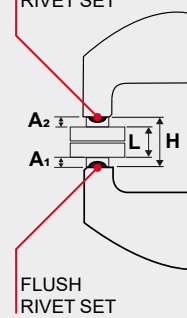

When two flush sets are used:

The length of the body dimensions of the rivet sets (A1, A2) should equal the closed height dimension of the yoke H minus the overall length of the rivet (L) after it is compressed.

$$A1 + A2 = H - L$$

Rivet sets



Shank type	'A' body length		AN-470 UNIVERSAL
	inch	mm	Part #
CR-1	1/8"	3.2	P089495
CR-1	1/4"	6.4	P089496
CR-1	3/8"	9.5	P089497
CR-1	1/2"	12.7	P089498
CR-1	5/8"	15.9	P089499

Shank type	Rivet diameter		'A' body length		AN-470 UNIVERSAL
	inch	mm	inch	mm	Part #
CR-1	3/32"	2.4	1/4"	6.4	P089430
CR-1	3/32"	2.4	3/8"	9.5	P089431
CR-1	3/32"	2.4	1/2"	12.7	P089432
CR-1	1/8"	3.2	1/4"	6.4	P089435
CR-1	1/8"	3.2	3/8"	9.5	P089436
CR-1	1/8"	3.2	1/2"	12.7	P089437
CR-1	5/32"	3.2	1/4"	6.4	P089440
CR-1	5/32"	4.0	3/8"	9.5	P089441
CR-1	5/32"	4.0	1/2"	12.7	P089442
CR-1	3/16"	4.0	1/4"	6.4	P089445
CR-1	3/16"	4.8	3/8"	9.5	P089446
CR-1	3/16"	4.8	1/2"	12.7	P089447

Over 110 years of experience

Since 1901 the Chicago Pneumatic (CP) name has represented reliability and attention to customer needs, with construction, maintenance and production tools and compressors designed for specific industrial applications. Today, CP has a global reach, with local distributors around the world.

Our people start every single day with a passion to research, develop, manufacture and deliver new products that are meant to meet your needs not only today, but tomorrow as well.

To learn more about our extensive range of tools, construction equipment, industrial and portable compressors, accessories and workshop equipment, please visit www.cp.com.

AIR LINE ACCESSORIES

Tool inlet size		Type	Tool max air consumption		Hose Recommended Diameter	
1/4"	6.5 mm	NPT	6 cfm	2.83 l/s	3/8"	10 mm

MUST HAVE

FRL



Metallic FRL
1/4" NPT
2 stages 8940168515
3 stages 8940168516

COUPLING & NIPPLE

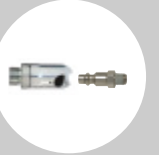

EF Coupling Male
1/4" NPT
6158105490

Nipple Male

1/4" NPT
6158105620

SAFETY

AIR FUSE



Air Fuse Low Flow
1/4" NPT
6158112450

HOSE CONNECTOR

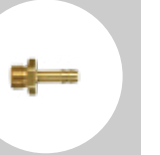

Hose connector
1/4" NPT
Diameter 3/8" / 10 mm
8940175942

MUST HAVE

HOSE & CLAMPS



Effi Max Hose
Diameter 3/8" / 10 mm
8940169921

Simple Pressure Clamp

Diameter 3/8" / 10 mm
6158109850
<i>Order 2 units</i>

COUPLING & NIPPLE

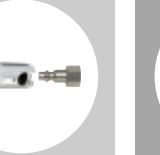

EF Coupling Hose connector
Diameter 3/8" / 10mm
6158105320

Nipple Female

1/4" NPT
6158105650

SAFETY & ERGONOMICS

HOSE WHIP



Hose Whip
Thread 1/4"
Diameter 3/8" / 10 mm
CA047270

*Set up made with EF coupling ISO6150B type (NA, France, Italy)

TUNE-UP KIT

Tool model	Part number
CP4210CS (Serie C)	6153996450
CP4220CS (Serie C)	
CP4210AS (Serie C)	
CP4210AL (Serie C)	
CP4220AS (Serie C)	6153996550
CP4220AL (Serie C)	

OIL

Part number	Volume
CA149661	4 oz / 20 ml
CA000046	20.8 oz / 591 ml
P089507	1 gal. / 3.8 L



For more information, please contact your Chicago Pneumatic partner:



www.cp.com